

OmniStream 121 Single-Channel Networked AV Decoder

AT-OMNI-121



The Atlona **AT-OMNI-121** is a networked AV decoder for HDMI / HDCP 2.2 output supporting resolutions up to 4K/60 4:4:4 and HDR (High Dynamic Range), plus audio embedding and de-embedding, and RS-232 or IR control pass-through. **OmniStream** is designed for high performance, flexible distribution of AV over standard, off-the-shelf Gigabit Ethernet switches in commercial audiovisual applications. The OMNI-121 decoder features the advanced VCx™ codec which delivers 4K/60 4:4:4 video from encode to decode, with artifact-free presentation of computer-generated content and fast-motion video, and ultra-low latency less than one frame. Additionally, the OMNI-121 features multiview window processing, with the ability to ingest up to four streams from AT-OMNI-111 encoders and display them simultaneously on a single screen. This decoder is housed in a half-width rack enclosure with front-to-back air flow, and is ideal for high-density, compact installation in distributed, multi-display installations.

Package Contents

- 1 x AT-OMNI-121
- 1 x Captive screw connector, 3-pin
- 1 x Captive screw connector, 5-pin
- 1 x Push spring connector, 6-pin
- 2 x Push spring connectors, 5-pin
- 1 x Wall/table mounting brackets

Operating Notes

- OmniStream uses mDNS as the discovery mechanism. In order for mDNS to function properly, there must not be restrictions applied to the network.



IMPORTANT: Visit <http://www.atlona.com/product/AT-OMNI-121> for the latest firmware updates and User Manual.

Panel Descriptions

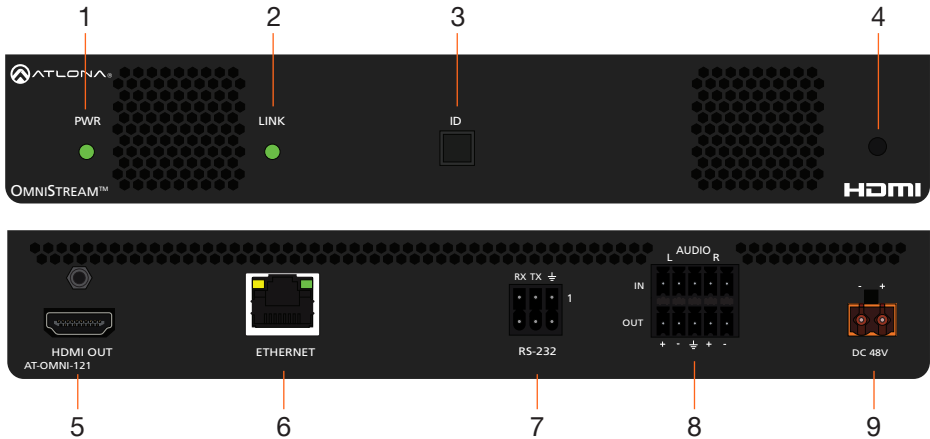

1 PWR

This LED indicator is green when the unit is powered and booted.

2 LINK

This LED indicator is green when the link integrity between the decoder and the network switch is good.

3 ID

This button provides two functions:

- (1) Press and release this button to send a broadcast network notification to any devices that may be listening (Velocity).
- (2) Press and hold this button for 30 seconds to perform a factory-reset of the unit. Refer to the OmniStream Decoder User Manual for more information.

4 REBOOT

Use a pointed object to press this recessed button and reboot the unit.

5 HDMI OUT

Connect an HDMI cable from this port to a UHD/HD display.

6 ETHERNET

Connect an Ethernet cable from this port to the Local Area Network (LAN).

7 RS-232

Use the included Euroblock push-spring connector to connect an RS-232 device to this port.

8 AUDIO IN / OUT

Connect the included Euroblock push-spring connectors to the **AUDIO IN** port to embed audio on the **HDMI OUT** port. To de-embed the HDMI audio, connect the push-spring connectors to the **AUDIO OUT** port. Refer to **Audio** on page 6 for more information.

9 DC 48V

Connect the optional 48V DC power supply to this power receptacle. This power supply is available, separately, and is required for embedding and de-embedding of analog audio.

Installation

1. Connect an Ethernet cable from the **ETHERNET** port on the decoder to a PoE-capable switch on the Local Area Network (LAN). Note that if a PoE-capable switch is not available, the 48V DC power supply (sold separately) must be connected to the decoder.
2. Connect an HDMI cable from the UHD/HD display to the **HDMI OUT** port on the decoder.
3. If using RS-232, connect the included 6-pin Euroblock push-spring connector to the **RS-232** port on the decoder.
4. The **PWR** indicator, on the front panel, display the power status of the decoder. When the decoder is powered, using either PoE or the optional 48V DC power supply (not included), the LED initially turns red. After a few moments it will turn amber, and finally green.

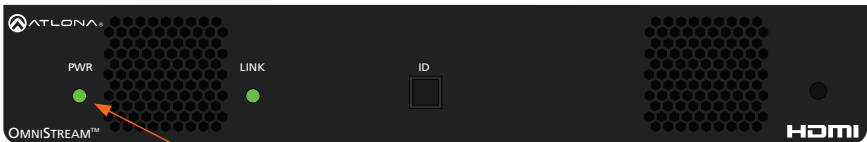

PWR indicator

Power Supply (optional)

The AT-OMNI-121 is powered by PoE (Power over Ethernet), when connected to a PoE-capable switch. If a PoE-switch is not used, then the optional 48 V power supply (Atlona part no. AT-PS-48083-C) can be purchased, separately. Insert the positive and negative leads, from the power supply, into the terminals of the 2-pin captive screw connector block, as shown. The orange 2-pin captive screw connector block is included with the OmniStream power supply package.



IMPORTANT: The external power supply must be connected to the decoder when embedding and de-embedding audio using the **AUDIO IN** and/or **AUDIO OUT** ports.

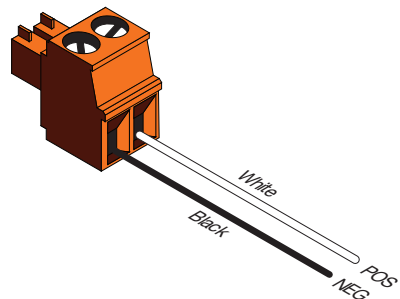
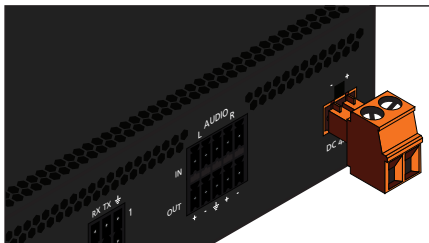

RS-232

The AT-OMNI-121 provides transport of RS-232 protocol over IP which allows communication between a control system and an RS-232 device. This step is optional.

1. Use wire strippers to remove a portion of the cable jacket.
2. Remove at least 3/16" (5 mm) from the insulation of the RX, TX, and GND wires.
3. Insert the TX, RX, and GND wires into correct terminal on the included captive screw connector, following the wiring diagram below.

Note that the included 6-pin push-spring connector can be used, if desired, in place of the captive screw connector. Only the **RS-232 1** port is available on the decoder.



NOTE: Typical DB9 connectors use pin 2 for TX, pin 3 for RX, and pin 5 for ground. On some devices, the function of pins 2 and 3 are reversed.

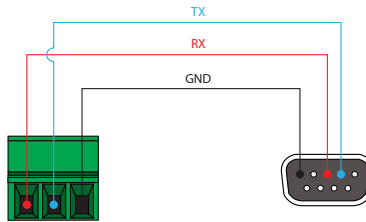
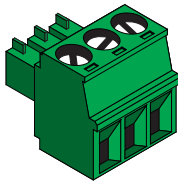

IR

The same port that provides RS-232 connections also supports bidirectional IR pass-through, allowing a device to be controlled from either the headend or the decoder endpoint. This step is optional. IR control is only supported on RS-232 2 port (bottom set of connectors).

IR emitter configuration

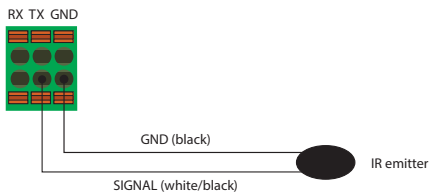

IR extender configuration

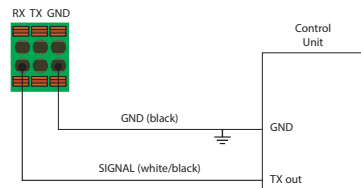

Audio

The AT-OMNI-121 provides the ability to embed 2-channel analog audio on the **HDMI OUT** port or de-embed HDMI audio on the **AUDIO OUT** port. De-embedded HDMI audio is downmixed to 2-channel PCM. This step is optional.

! IMPORTANT: Audio embedding and de-embedding, using the analog audio outputs, requires the optional OmniStream power supply (AT-PS-48083-C).

- If **AUDIO IN** or **AUDIO OUT** will be used, then connect the included 5-pin captive screw connectors, as shown below.

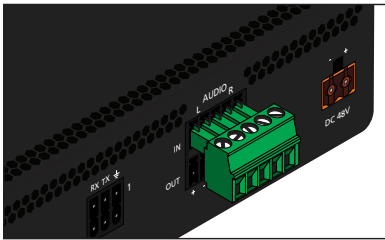

2-channel analog audio input (top)

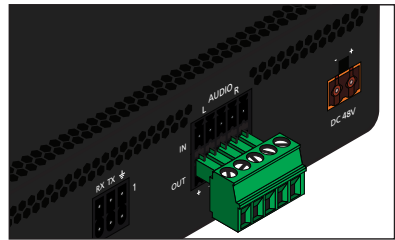

2-channel analog audio output (bottom)

- If both **AUDIO IN** and **AUDIO OUT** ports will be used, then connect the included 5-pin push spring connectors, as shown below.

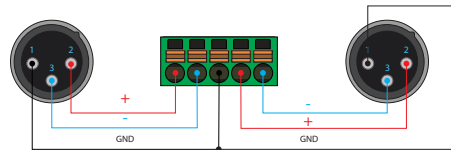
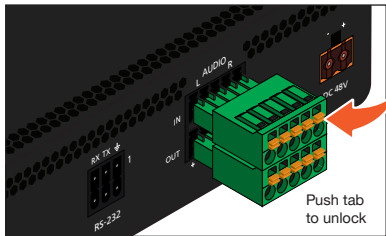

Balanced XLR audio

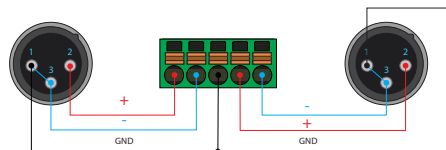

Unbalanced XLR audio

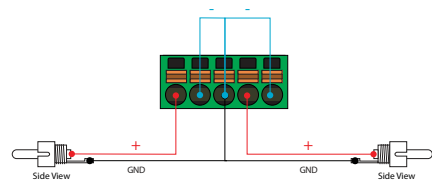

Unbalanced RCA audio

If using non-tinned stranded wire, press the orange tab, above the terminal, while inserting the exposed wire

i NOTE: Unbalanced XLR audio requires Pin 1 and Pin 3 to be connected. The same wiring applies to both captive screw and push spring connectors.

Accessing OmniStream using the built-in Web Server

1. Launch the desired web browser and enter the IP address or domain name of the decoder in the address bar.
2. Enter the username and password. Note that the password field will always be masked. The default credentials are:

Username: admin
 Password: Atlona

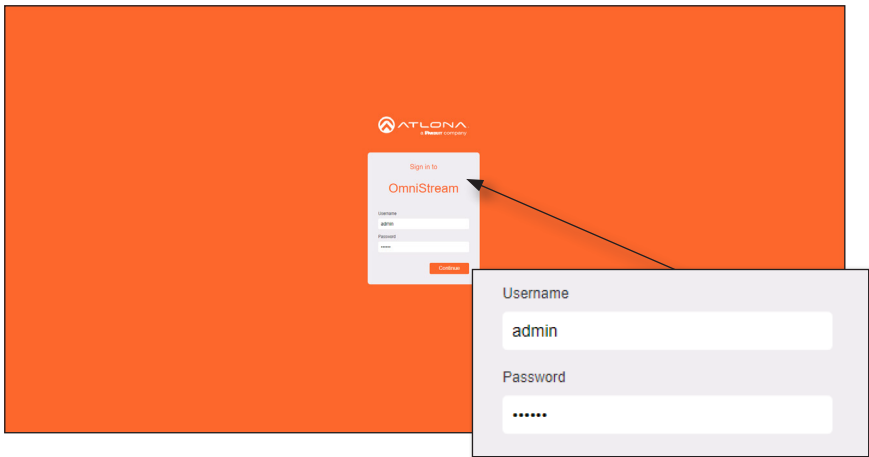

3. The System Information page will be displayed.

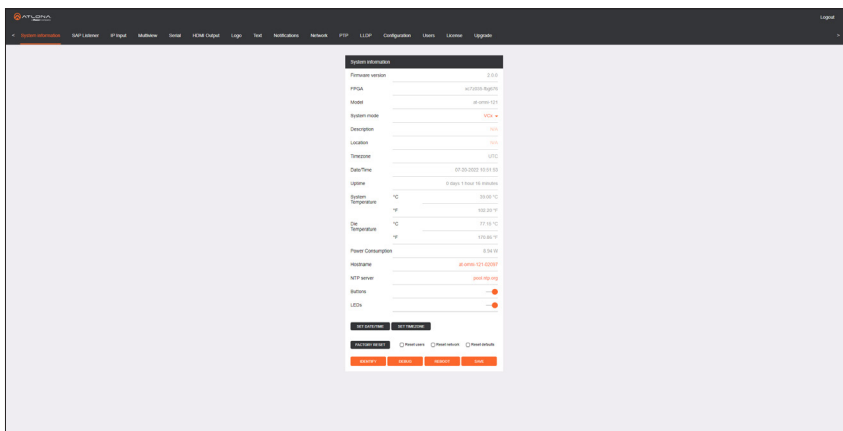

Mounting Instructions

The AT-OMNI-121 decoder includes two mounting brackets and four mounting screws, which can be used to attach the unit to any flat surface.

- Using a small Phillips screwdriver, remove the two screws from the left side of the enclosure.

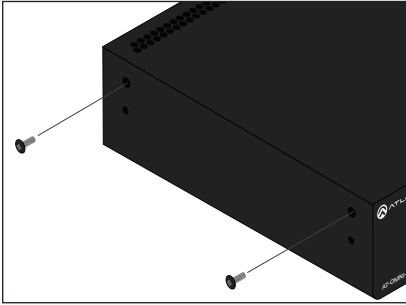

- Position one of the mounting brackets, as shown below, aligning the holes on the side of the enclosure with one set of holes on the mounting bracket.
- Use the enclosure screws to secure the mounting bracket to the enclosure.

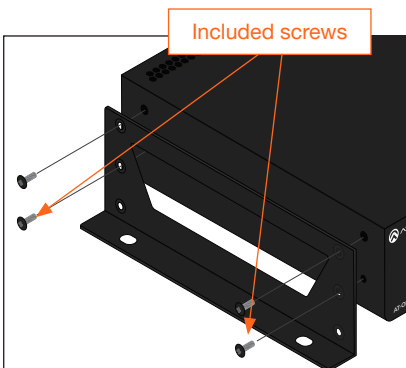

- To provide added stability to the mounting bracket, use two of the included screws and attach them to the two holes, directly below the enclosure screws, as shown above.

- Repeat steps 1 through 4 to attach the second mounting bracket to the opposite side of the unit.
- Mount the unit using the oval-shaped holes, on each mounting bracket. If using a drywall surface, a #6 drywall screw is recommended.

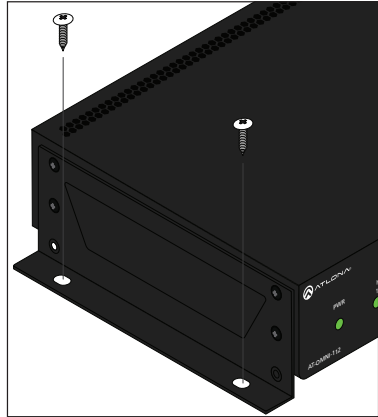

NOTE: Mounting brackets can also be inverted to mount the unit under a table or other flat surface.

Warranty

To view the product warranty, use the following link or QR code:

<https://atlona.com/warranty/>.



Version 4

English Declaration of Conformity

The English version can be found under the resources tab at:

<https://atlona.com/product/at-omni-121/>.



Chinese Declaration of Conformity 中国RoHS合格声明

由SKU列出於:

<https://atlona.com/about-us/china-rohs/>.



The terms HDMI, HDMI High-Definition Multimedia Interface, and the HDMI Logo are trademarks or registered trademarks of HDMI licensing Administrator, Inc.