

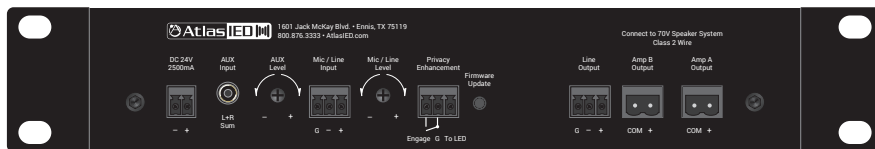

ASP-MG2240 Amplified Sound Masking System

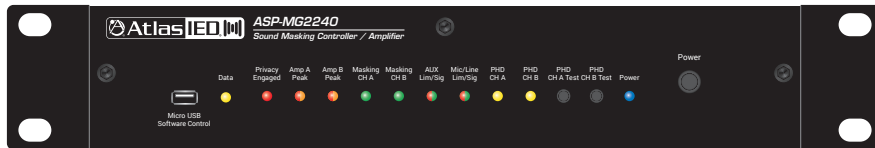

ASP-MG2240

Owner's Manual

Table of Contents

Important Safety Instructions.....	3
Introduction	5
Key Features.....	6
Package Contents.....	6
Applications	6
Front Panel Description	7
Rear Panel Description	8
Installing the Software	9
Connecting the ASP-MG2240 to a PC	10
Opening the Software	11
Identifying the Software or Firmware Version.....	12
Overview of the GUI	13
Saving and Recalling Projects from the ASP-MG2240.....	14
Saving and Recalling Projects from a PC	16
Settings Menu	18
Mixer Levels GUI Page.....	19
Mic / Line Settings GUI Page	20
AUX Settings GUI Page.....	21
Masking A and B GUI Page.....	22
7 Day Masking Scheduler & System Commissioning Ramp Page	23
Privacy Enhancement Example	25
Using the Push Here Diagnostic Feature	28
How to Troubleshoot Your Loudspeaker System if the PHD LED is Illuminating	30
ASP-MG2240 Application Examples	32
Block Diagram	34
Rack Mount Kit.....	35
Specifications	37
Warranty	44

ASP-MG2240

Owner's Manual

Important Safety Instructions

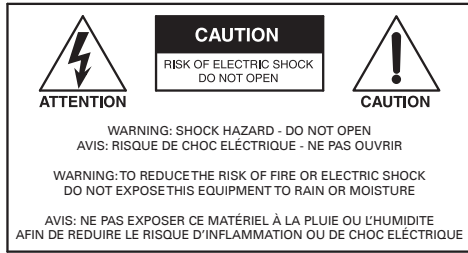

The lightning flash with arrowhead symbol within an equilateral triangle, is intended to alert the user to the presence of uninsulated "dangerous voltage" within the product's enclosure that may be of sufficient magnitude to constitute a risk of electric shock to persons.



The exclamation point within an equilateral triangle is intended to alert the user to the presence of important operating and maintenance (servicing) instructions in the literature accompanying the product.

1. Read these instructions.
2. Keep these instructions.
3. Heed all warnings.
4. Follow all instructions.
5. Do not use this device near water.
6. Clean only with dry cloth.
7. Do not block any ventilation openings. Install in accordance with the manufacturer's instructions.
8. Do not install near any heat sources such as radiators, heat registers, stoves, or other devices that produce heat.
9. Do not defeat the safety purpose of the polarized or grounding-type plug. A polarized plug has two blades with one wider than the other. A grounding type plug has two blades and a third grounding prong. The wide blade or the third prong are provided for your safety. If the provided plug does not fit into your outlet, consult an electrician for replacement of the obsolete outlet.
10. Protect the power cord from being walked on or pinched particularly at plugs, convenience receptacles, and the point where they exit from the device.
11. Only use attachments / accessories specified by the manufacturer.
12. Use only with the cart, stand, tripod, bracket, or table specified by the manufacturer, or sold with the device. When a cart is used, use caution when moving the cart / device combination to avoid injury from tip-over.



13. This product is equipped with a three-wire grounding-type plug, a plug having a third (grounding) pin. This plug will only fit into a grounding-type power outlet. This is a safety feature. If you are unable to insert the plug into the outlet, contact your electrician to replace your obsolete outlet. Do not defeat the safety purpose of the grounding-type plug.
14. Unplug this device during lightning storms or when unused for long periods of time.
15. Refer all servicing to qualified service personnel. Servicing is required when the device has been damaged in any way, such as power-supply cord or plug is damaged, liquid has been spilled, or objects have fallen into the device, the device has been exposed to rain or moisture, does not operate normally, or has been dropped.
16. **WARNING:** To reduce the risk of fire or electric shock, this device should not be exposed to rain or moisture and objects filled with liquids, such as a vase, should not be placed on this device.
17. To completely disconnect this equipment from the mains, disconnect the power supply cord plug from the receptacle.
18. The mains plug of the power supply cord shall remain readily operable.
19. Protective earthing terminal. The apparatus should be connected to a mains socket with a protective earthing connection.

ASP-MG2240

Owner's Manual



WARNING - When The Device Is In Use

- **WARNING:** The terminals marked with symbol of may be of sufficient magnitude to constitute a risk of electric shock. The external wiring connected to the terminals requires installation by an instructed person or the used of ready-made leads or cords.
- **WARNING:** The apparatus shall not be exposed to dripping or splashing and that objects filled with liquids, such as vases, shall not be placed on apparatus.
- **WARNING:** The mains plug is used as disconnect device, the disconnect device shall remain readily operable.
- To prevent electric shock, do not remove the product cover as there are high voltage components inside. Refer all servicing to AtlasIED.
- Should any of the following irregularities occur during use, immediately switch off the power, disconnect the power cord from the AC outlet and contact AtlasIED. Do not to attempt to continue operation with the product as this may cause fire or electric shock:
 - Smoke or strange smell coming from the unit.
 - If the product falls or the case is damaged.
 - If water or any metallic objects falls into the product.
 - If the power supply cord is damaged in any way.
 - If the unit is malfunctioning.
- Do not insert or drop metallic objects or flammable materials into the ventilation holes of the product's cover, as this may result in electric shock or fire.
- Do not place any containers with liquid or metallic objects on the top of the product. If any liquid spills into the unit, fire or electric shock may result.
- Never operate this product or touch the power supply cord during an electrical storm, electric shock may result.
- Never exceed the power rating on the product when connecting equipment. Fire and/or property damage may result.
- Operate the product only with the voltage specified on the unit. Fire and/or electric shock may result if a higher voltage is used.
- Do not modify, kink, or cut the power cord. Do not place the power cord in close proximity to heaters and do not place heavy objects on the power cord, including the product itself, doing so may result in fire or electrical shock.
- Ensure that the safety ground terminal is connected to a proper ground. Never connect the ground to a gas pipe as a catastrophic disaster may result.
- Be sure the installation of the product is stable, avoid slanted surfaces as the product may fall and cause injury or property damage.



CAUTION - When Installing The Product

- Plugging in or unplugging the power cord with wet hands may result in electric shock.
- Never move the unit with the power cord plugged into the wall, as damage to the power cord may result.
- When unplugging the cord from the wall, grasp the plug, NOT the cord.
- Never install this product in humid or dusty locations, nor in direct sunlight, near sources of heat, or in areas where sooty smoke or steam are present. Fire and electric shock may result.
- Keep all sides of the unit at least 3¹/₂" away from objects that may obstruct air flow to prevent the unit's internal temperature rise.



CAUTION - When The Product Is In Use

- Never place heavy objects on the product, causing it to fall and/or break, resulting in personal injury and property damage. In addition, the product itself may fall and cause injury and property damage.
- Contact AtlasIED for instructions on cleaning the inside of the unit. Large accumulations of dust inside the unit may result in heat buildup and fire.
- Ensure that the power supply plug is securely plugged into the wall outlet. Never allow dust to accumulate on the power plug or inside the wall outlet.
- When cleaning the unit or the unit is not to be operated for an extended period, unplug the power cord from the wall.

ASP-MG2240

Owner's Manual

Introduction

Thank you for purchasing the AtlasIED ASP-MG2240 amplified sound masking system. The ASP-MG2240 is a two-zone sound-masking controller with integrated amplification. This compact design incorporates many useful features including two-channels of amplification, separate analog masking generators with EQ, 24Hr / 7-Day scheduler, system commissioning ramp, balanced mic / line input, auxiliary input for background audio, and a line output. The PC control software allows system customization to meet installation needs. Settings can be stored in the unit or in the PC for file backup or recall. The ASP-MG2240 offers industry leading pre-configured presets that are tailor made for many common and advanced masking applications. These settings are based on AtlasIED proprietary Chanaud Masking Filters. These unique filters have been approved and implemented in many installations including secured government facilities.

The compact ASP-MG2240 can deliver quality audio in a single masking zone up to 7000 sq. ft. or can be spilt into two 3500 sq. ft. zones. This compact integrated solution features two internal 30-watt amplifier channels including internal DSP with intuitive control software. The software makes setup fast because preset configurations are preloaded and can be selected and modified for customization.

The ASPMG2240 features a customizable speech privacy solution for any environment. Speech Privacy Enhancement for conference rooms or medical offices, required by HIPAA law, is now simply executed. When in a private meeting that requires speech privacy, simply press a switch to activate the Speech Privacy Enhancement mode. A variety of optional Speech Privacy Enhancement signs are available to connect to the ASP-MG2240 that provide a visual indicator when the room is secure for speech privacy.

The ASP-MG2240 is an all-in-one solution that not only supplies speech privacy, but also can deliver paging and background audio. Mic/line and Auxiliary inputs each have a selectable 5-band equalizer and Hi and Lo pass filters. For paging applications, the ASP-MG2240 incorporates a unique hi Q feedback filter specifically tailored to the vocal frequency range. Adjustable output limiters are in the audio chain to protect against system overdrive.

The ASP-MG2240 includes a patent pending automatic diagnostic system test, Push Here Diagnostic (PHD). The PHD button is designed to check the connected loudspeaker lines for wiring and amplifier loading errors. This test can be activated once all loudspeakers are connected and the circuit automatically verifies that the attached loudspeakers' tap settings do not exceed the amplifier's rated power and the loudspeaker wire is free from shorts ensuring years of trouble free operation.

The ASP-MG2240 is one the most energy efficient sound masking systems available today. The integrated amplifiers are more than 90% efficient and when combined with the 24/7 masking scheduler, the system has the perfect balance between audio performance and energy conservation. When the scheduler is set to minimum use, the ASP-MG2240 only draws 4.4W and during everyday use, the average power consumption is only 19W, and power consumption under maximum use is 67W.

ASP-MG2240

Owner's Manual

Key Features

- Amplified Masking Controller
- 2 Masking Zones
- 2 x 30-Watt Outputs
- Analog White and Pink Noise Generators
- Balanced Line Output for 3rd Zone
- Speech Enhanced Privacy Mode (Adjustable +/- 12dB)
- Mic / Line Input for Paging with EQ and Limiter
- Auxiliary Input for BGM with EQ and Limiter
- Push Here Diagnostic (PHD) System Test Circuitry
- Assignable Balanced Line Output
- DSP Parameters EQ, Hi and Lo Pass Filters, Limiter
- PC Software Control
- 24 / 7 Schedule for Each Output
- System Commissioning Ramp On Each Output

Package Contents

- ASP-MG2240 and I/O Connectors
- Power Supply 24VDC 2.5A (2500mA)
- Quick Start Guide
- Rack Mount Kit
- USB Drive
- USB to Micro USB Cable
- Rubber Feet

Applications

The ASP-MG2240 is suited for applications requiring a secured speech environment, paging or background music (BGM) audio. The ASP-MG2240 is designed to provide detailed masking privacy for a wide range of acoustical environments including open office areas, conference rooms, huddle/meeting rooms, as well as delivering non-masking content to areas where needed.

ASP-MG2240

Owner's Manual

Front Panel

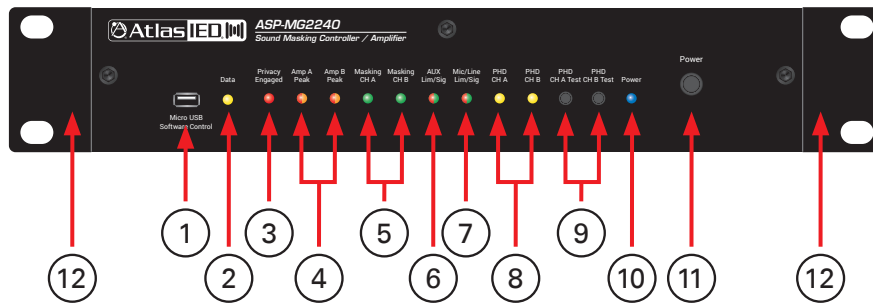

1. Micro USB Interface

This Micro USB port is for data communication between the ASP-MG2240 and a USB port on connected PC.

2. LED Data Indicator

LED blinks Yellow when the computer and the ASP-MG2240 have a connection and are communicating properly. **Note:** If power is lost to either device, the USB cable may have to be detached and then reattached.

3. LED Privacy Engaged Indicator

LED will illuminate Red when the rear panel Privacy Enhancement “G” and “Engage” are shorted together. **Note:** See application guide on how to use the Privacy Enhancement feature.

4. LED Amp A and B Peak Indicators

These LED indicators will illuminate Red when the output is -3dB of rated power.

5. LED Masking Channel A and B Indicators

These LED indicators will illuminate Green when the Masking CH A or B are active.

6. LED AUX Limit/Signal Indicator

This dual color LED indicator will illuminate Green when signal is present at the AUX input and will illuminate RED when the input limiter is engaged.

Note: The Limiter is adjustable.

7. LED Mic/Line Limit/Signal Indicator

This dual color LED indicator will illuminate Green when signal is present at the AUX input and will illuminate RED when the input limiter is engaged.

Note: The Limiter is adjustable.

8. LED PHD Channel A and B Indicators

When testing the CH A or B amplifier using the PHD automatic diagnostic system test, the associated channel LED will illuminate Yellow if a fault is detected in the loudspeaker system. See “Using the PHD Load Impedance Testing System”.

9. PHD Channel A and B Test Switches

The ASP-MG2240 features a patented Amplifier Diagnostic System. The PHD (Push Here Diagnostic) is simple to use but very effective in testing the loudspeaker wiring and load impedances on 70.7V loudspeaker systems to assure the proper load is applied to the amplifier. Please read the section on Using the PHD Feature before activating the circuit. The PHD CH A and B momentary test switch only diagnoses loads associated with the amplifier channel being tested.

10. LED Power Indicator

LED will illuminate Blue when the ASP-MG2240 power supply is plugged into the amp, power switch is pushed in, and the power supply has AC mains applied.

11. Power Switch

Press In to turn the amplifier ON and release the switch to power OFF.

12. Rack Ears

The ASP-MG2240 includes a rack mount kit that allows it to be mounted in a variety of enclosure conditions. Refer to the “ASP-MG2240 Rack Mount Guide” for more information.

ASP-MG2240

Owner's Manual

Rear Panel

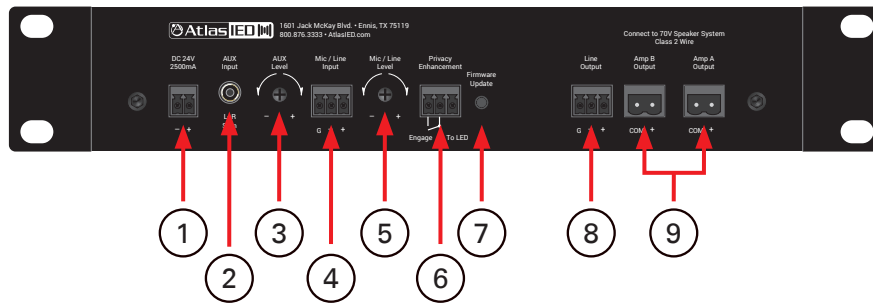

1. DC Power Input

The ASP-MG2240 comes with a global 24VDC 2500mA external power supply. The power supply is equipped with a 2-position 3.5mm connector that mates to this DC Power input socket. A cable restrain tie point is also provided next to this DC power input.

2. AUX Input

This receptacle accepts a 3.5mm stereo plug. The Left and Right inputs are actively stereo summed to form a mono signal. This signal can be routed to either the Amp A or Amp B amplifier channels via the GUI controls. The Input sensitivity can be adjusted in the GUI from 316mV – 1V. Factory default is 316mV to full output with all the level controls set to max or “0”.

3. AUX Level

This analog rotary level control adjusts the signal applied to the AUX input. The level control is PRE-any AUX level control in the software GUI. Turn clockwise to increase the signal level and counter-clockwise to decrease it.

4. Mic / Line Input

This 3-position 3.5mm connector is for balanced mic or line level sources. Gain or source input type selection is made via the GUI software. **Note:** Unbalanced line inputs can be inserted with proper wire configuration by connecting the (G) and (-) terminals together.

5. Mic / Line Level

This analog rotary level control adjusts the signal applied to the Mic / Line input. The level control is PRE-any Mic / line level control in the software GUI. Turn clockwise to increase the signal level and counter-clockwise to decrease it.

6. Privacy Enhancement

This control port is used to remotely activate the Speech Privacy Enhancement feature. When the “G” and “Engage” are shorted together a series of events happens.

- A. The front panel Privacy Engaged LED will illuminate Red.
- B. The Masking Level will change to the user preset privacy level.
- C. The port named “To LED” will supply a +10V DCV 100mA voltage to power an indicator LED sign.

Note: See the application guide on how to use the Privacy Enhancement feature.

7. Firmware Update

This switch is only used when a firmware update is needed. Follow the “Firmware Update Guide” to assure proper firmware installation. Failure to follow the procedure exactly may cause the unit to stop functioning properly.

8. Line Output

Provides balanced line output signal for a third zone using an external amplifier. Within the GUI software, a signal can be assigned from either the Amp A or Amp B output to this line output. The line output has its own independent level control in the GUI software.

Note: Unbalanced line level devices can be used with proper wire configuration by shorting the (G) and (-) terminals together.

9. Amp A and B Output

Connect the loudspeaker wiring to these terminals, observing the polarity shown on the rear of the chassis. Use the “COM” and “+” terminals.

For optimal performance ensure the sum of tapped loudspeakers does not exceed 20-watts per channel. **Note:** This is designed to work with 70.7V loudspeakers only.

ASP-MG2240

Owner's Manual

Installing the Software

1. The ASP-MG2240 includes a USB drive containing the operating software. **Note:** This software is only compatible with computers running Windows® operating systems, Windows® 7 or newer. The software will run on both 64- and 32-bit machines, but the installer will need to know what type of machine is being used. All computers running Windows® 8 or newer are 64-bit.
2. Make sure to uninstall any existing ASP-MG2240 software before installing the new version. Insert the USB drive into one of the USB ports on the PC. Open the file "ASP-MG2240 Soft V1.00" or greater (it will be an Application file with an .exe extension)

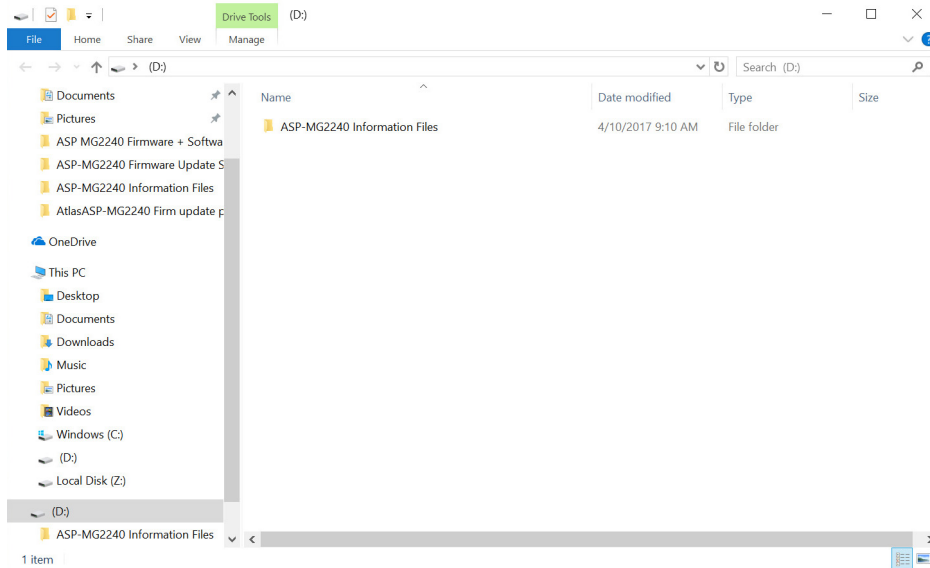

3. Follow the software loading installation steps. **Note:** There are two Driver loading windows. Select "Next" on both when prompted.

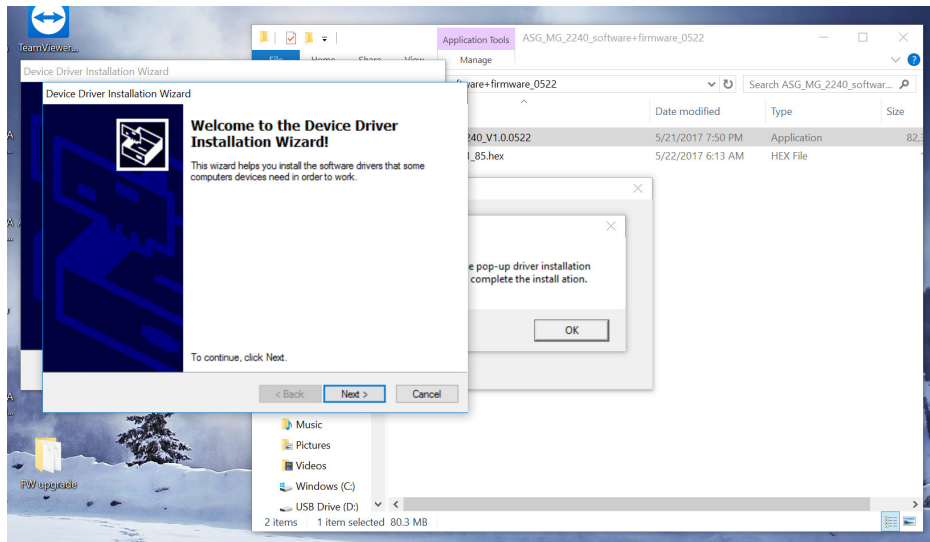

ASP-MG2240

Owner's Manual

Connecting the ASP-MG2240 to a PC

1. Install the Phoenix style connector from the power supply to the DC input port on the rear of the unit. Plug the 2-prong plug of the power cord into an AC power source. Turn the unit on via the Power Switch located on the front panel.

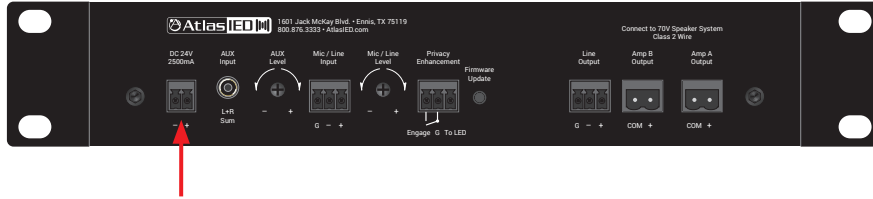

2. Connect the USB cable to the computer. Insert the Micro USB end into the port on the front of the ASP-MG2240. When connecting, an audible "chime" sound will be heard confirming the connection and the computer recognizes the USB driver.

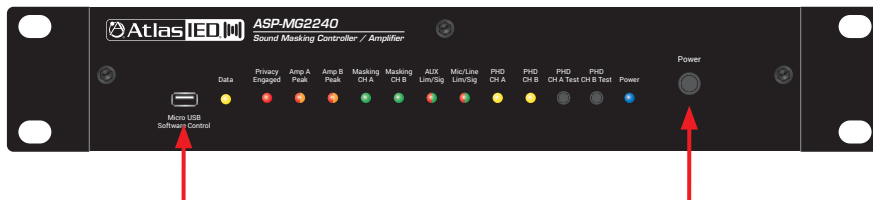

3. Confirm Connection - The Data LED in the GUI and on the front panel of the ASP-MG2240 will flash, confirming connection. The software must be open to see the flashing confirmation LED in the GUI.

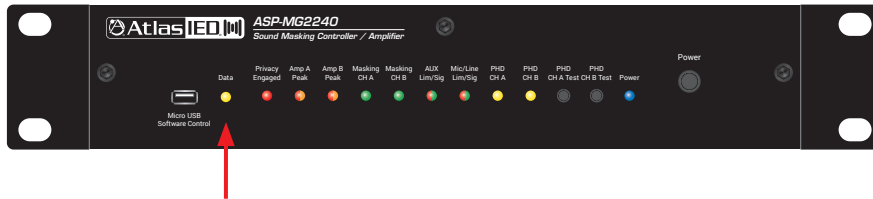

ASP-MG2240

Owner's Manual

Opening the Software

1. When opening the software, the user will be prompted to enter a valid User Name and Password. Factory default is the following:

- User Name - "admin"
- Password - "admin"

Note: These can be changed in the software by selecting "Settings" and then "Change Password." If the User Name or Password is lost, contact AtlasIED customer support at 1-800-876-3333 for master override codes.

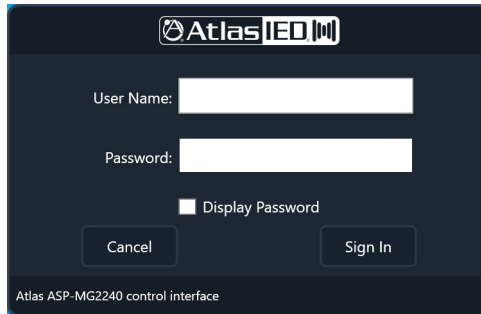

After logging in, the ASP-MG2240 will open and the following screen will appear. This is the Mixer Level control main page. If the software and the ASP-MG2240 are communicating the front panel and the GUI Data LED will be blinking amber.

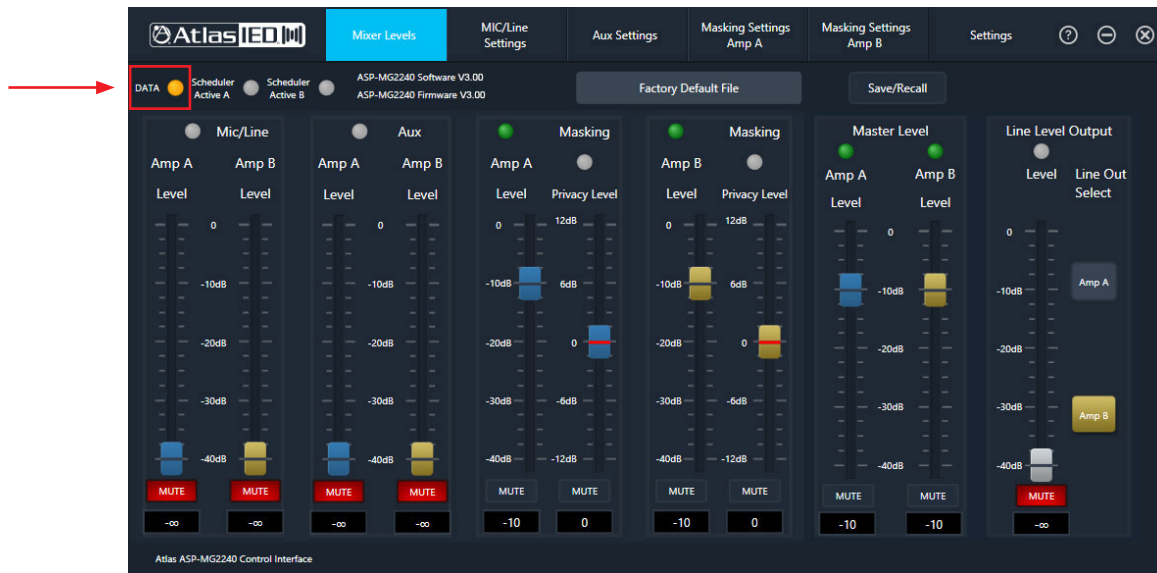

ASP-MG2240

Owner's Manual

Identifying the Software or Firmware Version

It is always a good practice to use the latest firmware and software to ensure the latest feature releases or bug fixes are being utilized. The image below identifies where to locate the firmware and software versions that are currently active on the device. The latest firmware and software can be found on the product page at atlasied.com/asp-mg2240. On that page select "Support Files" and look at the available software and firmware downloads. If the Firmware or the Software needs to be updated, follow the "Guide for ASP-MG2240 Software and Firmware upgrade" that can be found in the same "Support Files" section on the product webpage.

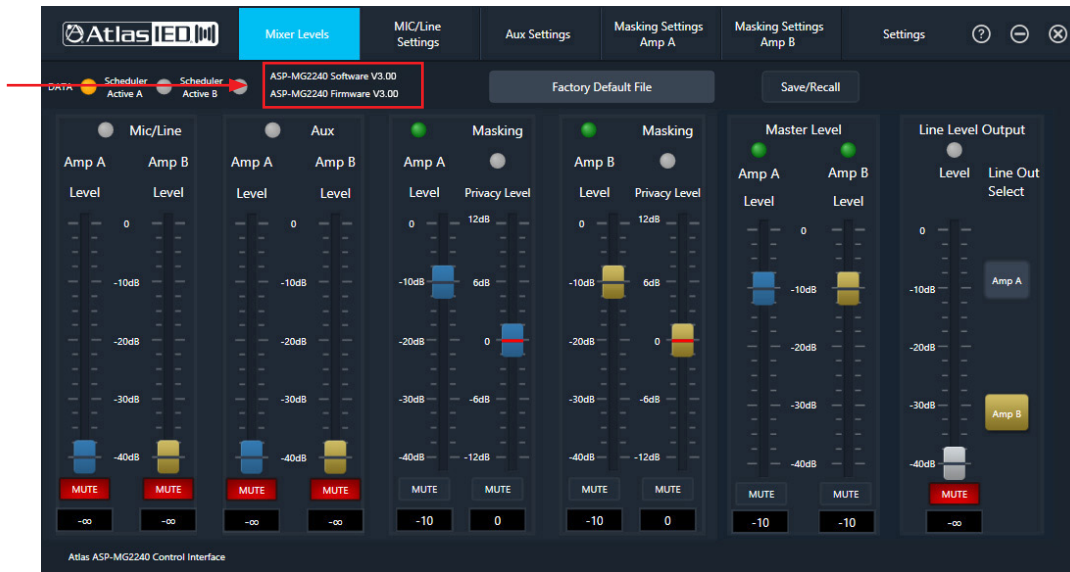

ASP-MG2240

Owner's Manual

Overview of the GUI

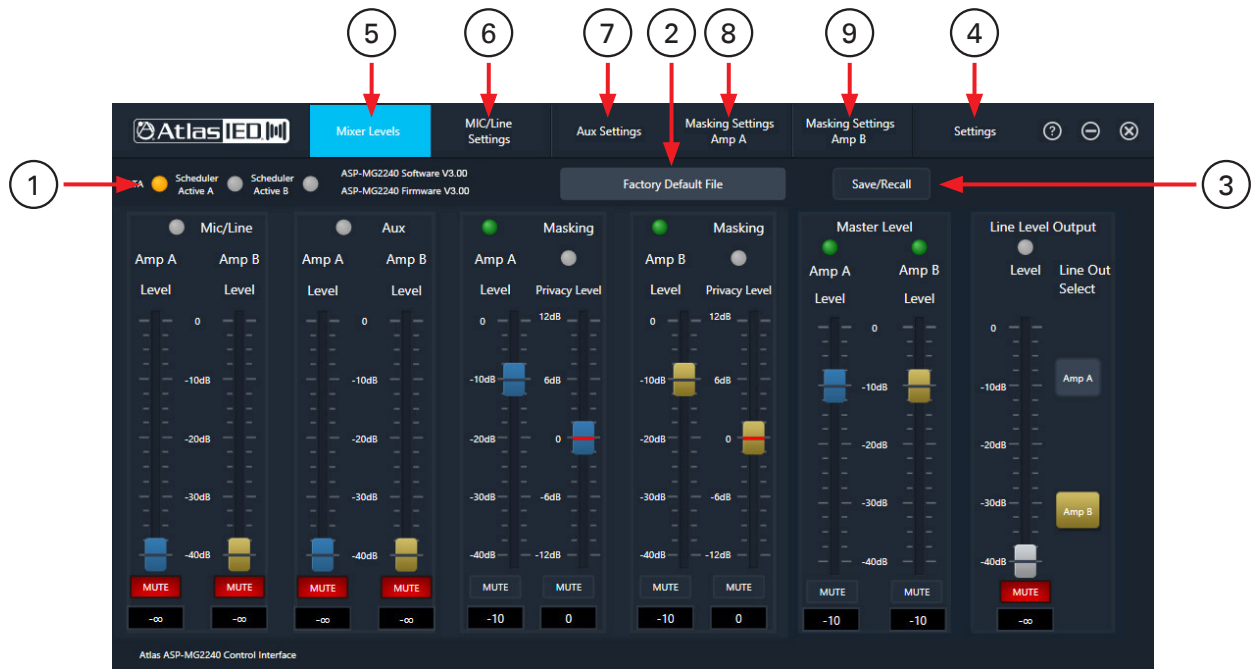

1. Data LED

Flashes when ASP-MG2240 and software are communicating properly. This corresponds with the front panel Data LED.

2. Active Project File

This box indicates the Project file that is currently loaded and active. The ASP-MG2240 has preconfigured files that are called Projects stored in the device. Out of the box the project that is active is called "Factory Default File." There are other files preloaded that are designed to work with most masking applications. Any of these files can be recalled, reconfigured and saved as a new Project. Refer to the "Save / Recall Project Files" section for more information.

3. Save / Recall button

This button has a drop-down menu that allows for files to be recalled or saved from the device or computer.

4. Settings Tab button

When selected a drop-down menu will appear with the following: "Reset To Default", "Change Password", "Master Login" and "About" Information. Refer to "Settings Menu" for details.

5. Mixer Levels Page

The Mic / Line, AUX, Masking Amp A, and Masking Amp B are Pre levels to the Master Level A and B Outputs. Line Output follows the Amp A or B settings and is PRE-the amplifier stage. Refer to the flow chart.

6. Mic / Line Page

This page allows for the input to be configured as Mic or Line with settings including Phantom On / Off, EQ settings, VOX Sensitivity, and Input Limiter.

7. AUX Page

This page controls the Auxiliary Stereo summed input sensitivity, Level, EQ, and Limiter.

8. Masking Settings Amp A

This page controls Amp A Masking levels, Pink or White noise generators, EQ, Privacy Enhancement level, and the 24 / 7 scheduler.

9. Masking Settings Amp B

This page controls Amp B Masking levels, Pink or White noise generators, EQ, Privacy Enhancement level, and the 24 / 7 scheduler.

ASP-MG2240

Owner's Manual

Saving and Recalling Projects from the ASP-MG2240

The ASP-MG2240 has preconfigured files that are called Projects stored in the device. Out of the box the project that is active is called "Factory Default File". There are other files preloaded that are designed to work with most masking applications. Any of these files can be recalled, reconfigured and saved as a new Project. The project name can be customized using up to 29 characters. There are 6 open locations available for custom projects.

Note: AtlasIED offers a variety of preconfigured project files on our web site that can be upload to the ASP-MG2240. Also available are project application guides on how to set up a system.

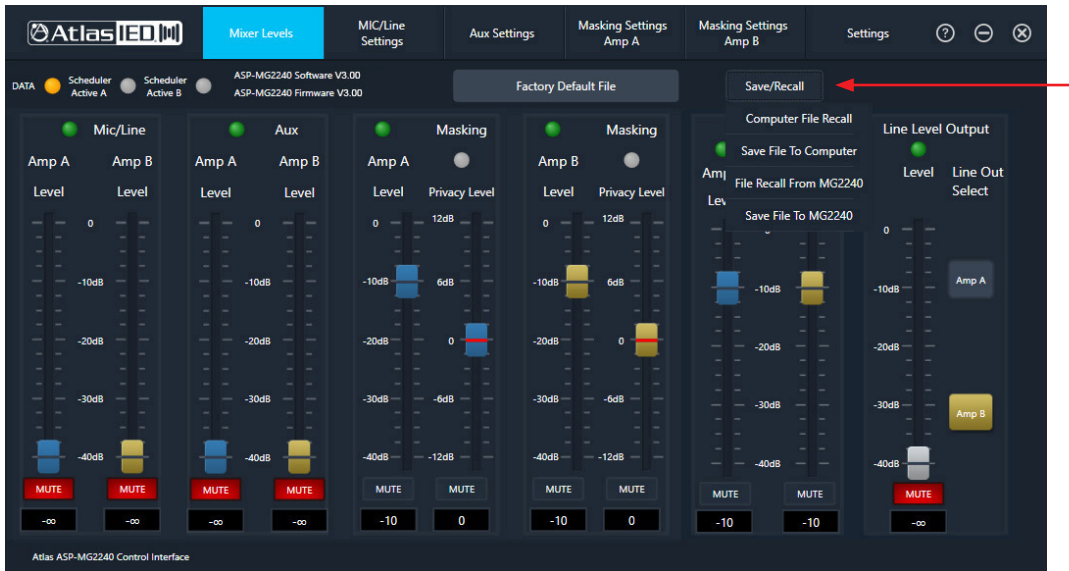

Saving a Project File to the ASP-MG2240

Click the Save / Recall tab, select "Save File to MG2240", select the Project location, and type in a new name or leave the default.

Note: If saving the project file to the ASP-MG2240 (also known as "Device Storing" the file), the current project file in that location will be overwritten. The factory project files are grayed out indicating they cannot be overwritten. See the example below.

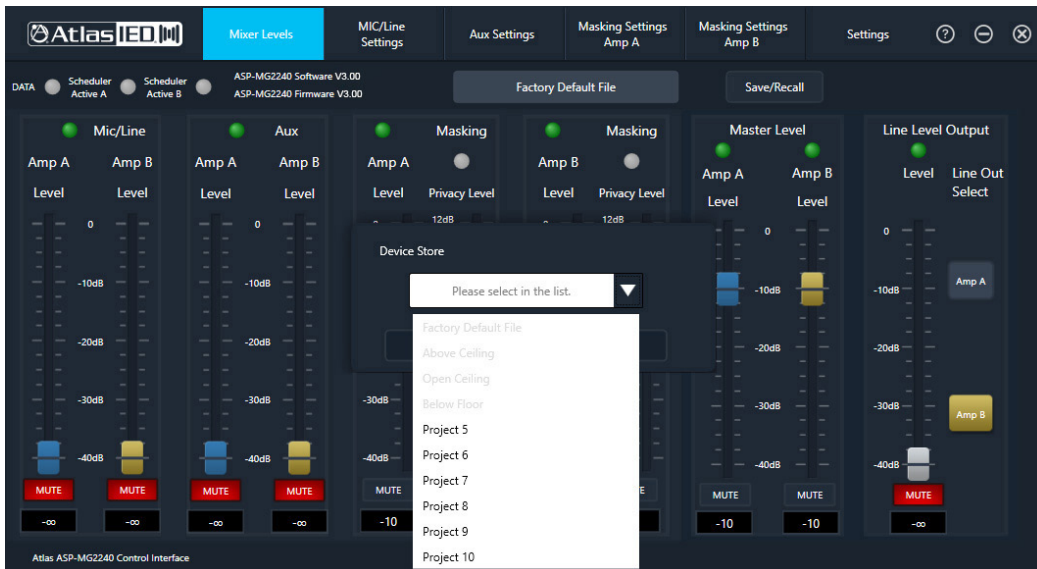

ASP-MG2240

Owner's Manual

Recalling a Project File from the ASP-MG2240

Click on the Save / Recall tab, select "File Recall From MG2240"; and Select the Project from the list wanted to recall or load into the ASP-MG2240. This is also known as "Device Recall". Make sure the new project file name is listed in the "Active Project File" box to confirm the chosen project file was loaded properly. See the example below.

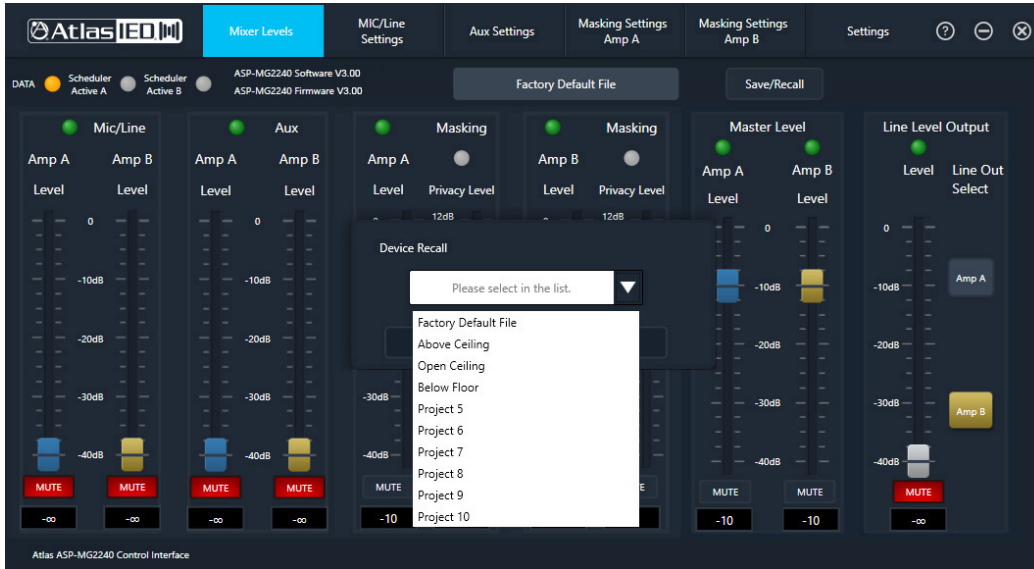

ASP-MG2240

Owner's Manual

Saving and Recalling Projects with a PC

Backing up custom Project files to a PC in case of a failure is strongly recommended. The ASP-MG2240 has preconfigured files that are called Projects stored in the device. In case these files do not fit the installation needs, AtlasIED offers a variety of preconfigured project files on our web site that can be uploaded to the ASP-MG2240.

Saving a Project File to a PC

It is very important to back up the configuration settings. Only one Project File at a time can be saved to a PC. Select the "Save / Recall" tab, then "Save File to Computer", and then browse for the location on the PC where the file will be stored. **Note:** The file extension must remain ".ASPMG". See the example below.

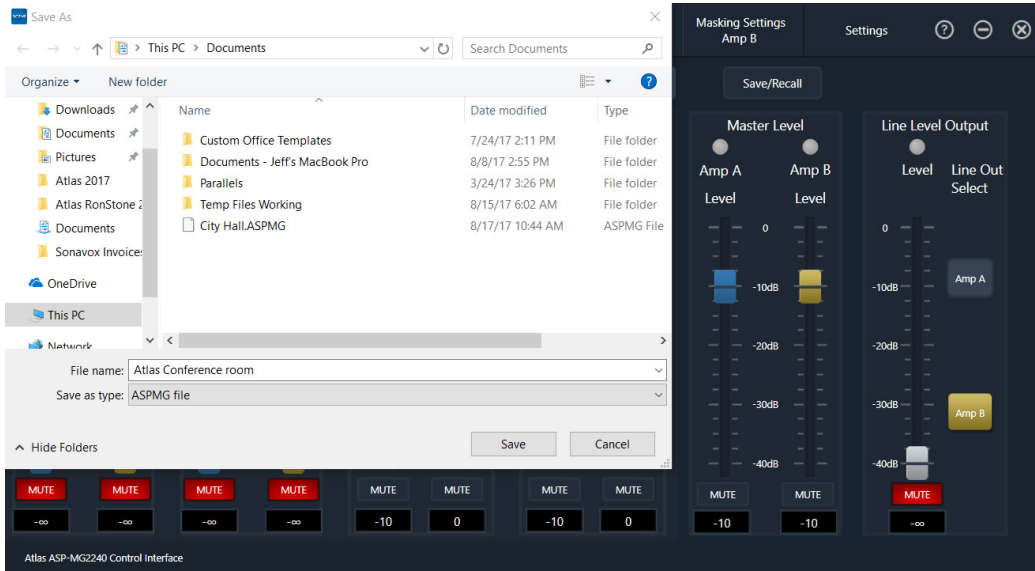

ASP-MG2240

Owner's Manual

Recalling a Project File from a PC

A quick way to program the ASP-MG2240 is by using a preconfigured custom project file that meets or is close to the installation design. **Note:** AtlasIED offers a variety of preconfigured project files on the web that can be uploaded to the ASP-MG2240. Also available are project application guides on how to set up a system. Select the "Save / Recall" tab, then "Computer File Recall"; and then browse for the location on the PC to locate the file to recall or upload the project file to the ASP-MG2240. See the example below.

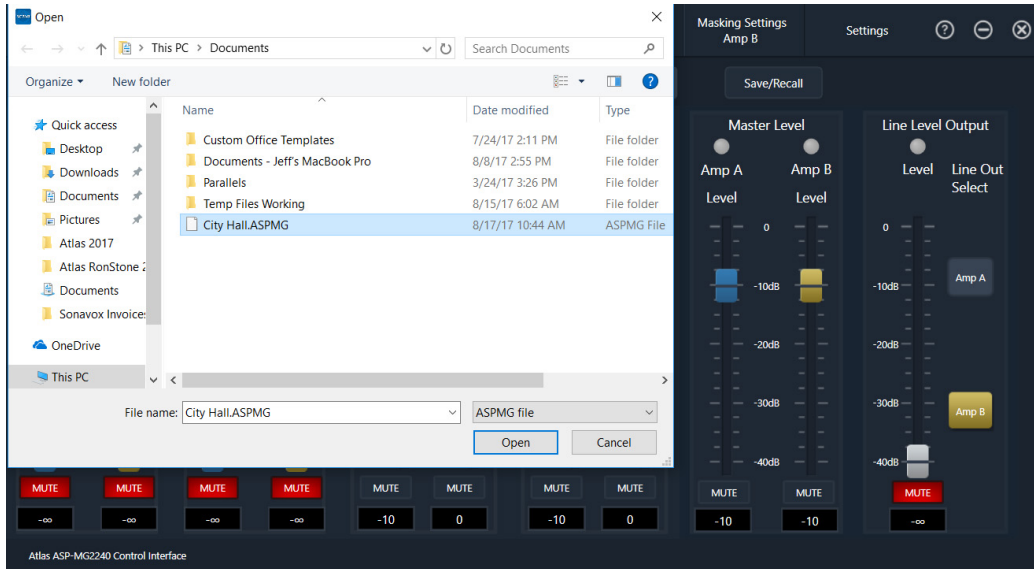

ASP-MG2240

Owner's Manual

Settings Menu

When selecting this tab, a drop-down menu will appear with the following options: "Reset To Default", "Change Password", "Master Login", and "About"

- Reset To Default - When selected the ASP-MG2240 will automatically load the Project file called "Factory Default File"
Note: Any previous loaded file settings will not be saved.
- Change Password - Allows the user to change the login User Name and Password. Factory default is User Name "admin" and Password "admin". If the User Name or Password is lost, contact AtlasIED customer support at 1-800-876-3333 for master override codes.
- Master Login - This is for factory use only.
- About - This window shows the Software and Firmware version numbers and release dates.



ASP-MG2240

Owner's Manual

Mixer Levels Page

This page is a quick access to all the Input and Output levels. **Note:** All faders have the same corresponding name no matter what page they are in.

Example: The AUX settings page faders, AUX A or B level, are the same fader as the AUX A and B level faders in the mixer page.



ASP-MG2240

Owner's Manual

Mic / Line Settings Page

This page allows you to adjust the parameters of the Microphone (Mic) or Line input. Select between Mic or Line input modes in this screen. **Note:** The GUI Level faders are POST (after) the rear panel Mic / Line Level control. All faders that have the corresponding name are the same no matter the page they are in.

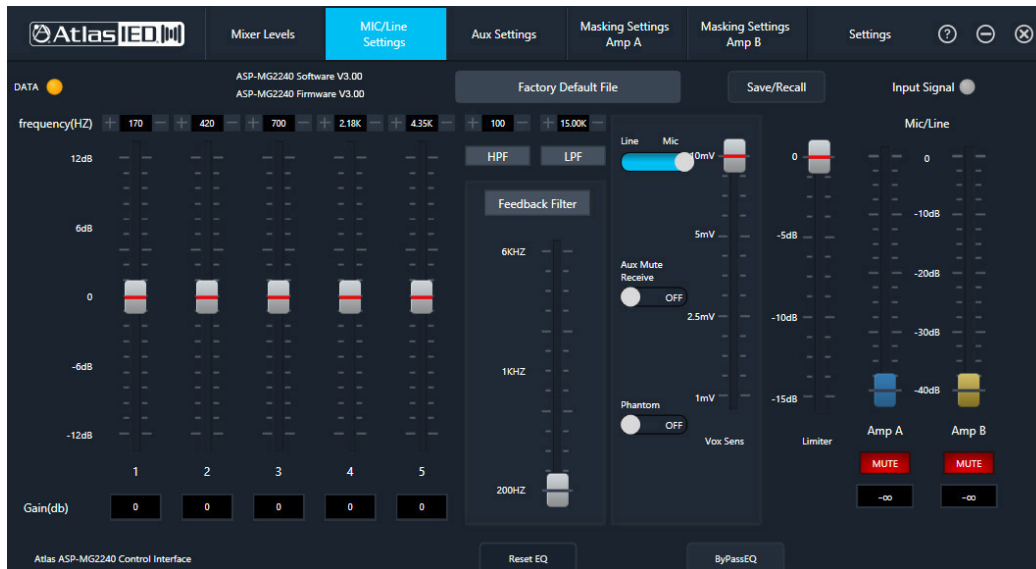

ASP-MG2240

Owner's Manual

AUX Settings Page

This page allows for adjustment of the parameters for the Auxiliary (AUX) stereo summed input. **Note:** The GUI level faders are POST (after) the rear panel AUX level control. All faders that have the corresponding name are the same no matter the page they are in.

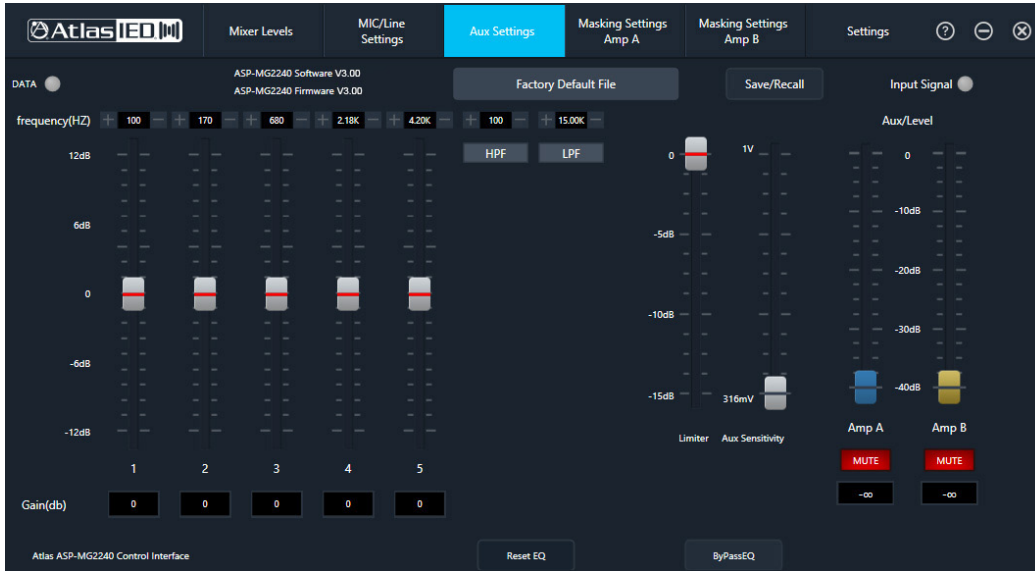

ASP-MG2240

Owner's Manual

Masking A and B Page

Both Masking A and B pages operate independently of each other but the features and functionality are the same. **Note:** All faders that have the corresponding name are the same no matter the page they are in.



ASP-MG2240

Owner's Manual

7 Day Masking Scheduler & System Commissioning Ramp

The ASP-MG2240 incorporates a 24-Hr / 7-day scheduler and a System Commissioning Ramp feature. Both are used to automatically adjust the Masking Level but are used for different functions.

The 24/7 Scheduler is a good way to increment the level of the Sound Masking so a person can ease into the work day but as the day progresses, the ambient noise typically gets louder requiring more speech privacy. To ensure the best speech privacy during these predicable times, the Sound Masking level needs to change with them. Depending on the type of business, weekends offices are usually closed. So, there may not be a need for Sound Masking on these days.

The System Commissioning Ramp "SCR" is a useful way for people to get acclimated over several days to the newly added enhanced speech privacy. Both Masking A and B have independent 24-Hr/7-day schedulers for ramping the masking levels to meet the environmental needs. The day of the week and the time is user set and will maintain the time even in the event of a power outage for up to 7 days. **Note:** The 24/7 Scheduler and the SCR never affects the AUX or Mic/Line levels, only the Masking A & B Levels.

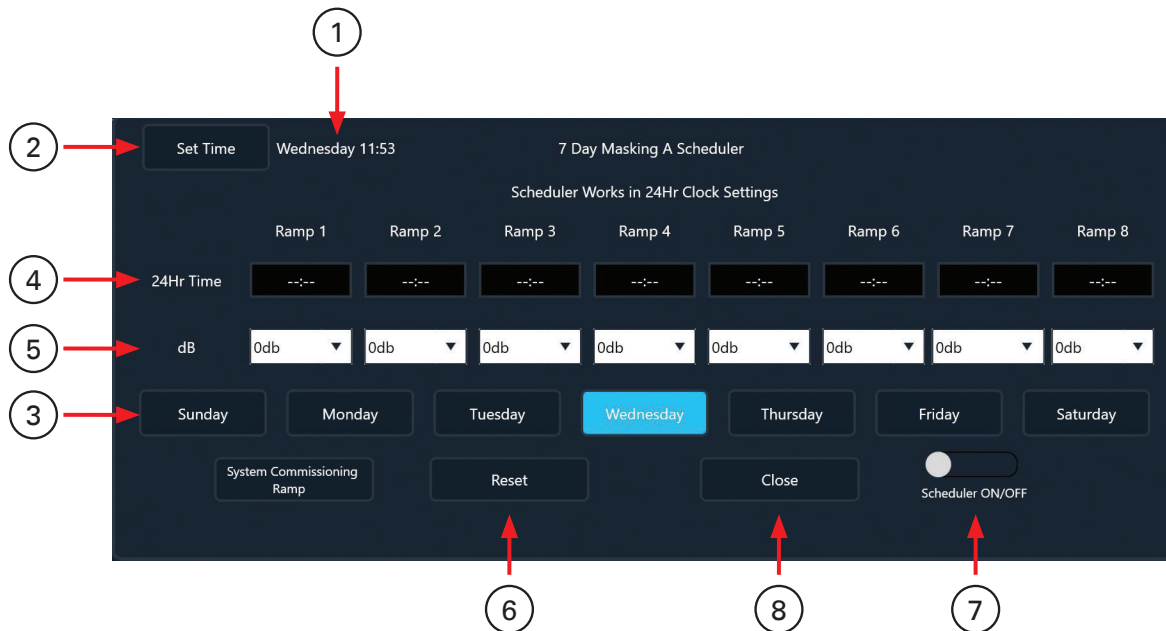

1. Current Time

This window reflects the real time internal clock setting of the ASP-MG2240. This time is not related to the computer time. If the time or day of the week is not correct, you will need to update the day and time. **Note:** Out of the box the time is not set, so this window will be blank. The clock does not adjust to Daylight Savings Time.

ASP-MG2240

Owner's Manual

2. Set Time

If the current time is not correct it can be updated by selecting the "Set Time" box. A window will pop up allowing the user to set the time of the day in a 24-hour format and the current day of the week. Select the "Save" tab to complete the clock setting. The time or day will not change if "Save" is not selected. **Note:** It is important to set the time to the time zone the ASP-MG2240 will be located.

24 Hour Time Information

- Also known as Military time.
- 00:00 = 12 Midnight and is start of the new day.
- 01:00 = 1 AM
- 13:00 = 1 PM
- 23:00 = 11 PM
- 23:59 is the last minute of the day.
- --:-- means no time is set

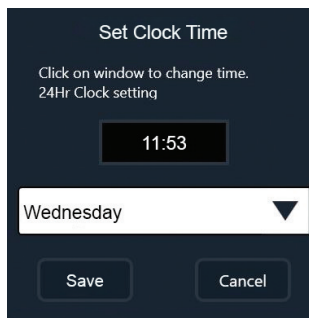

3. Scheduler Day of the Week

Each day of the week can have 8 ramp times. After selecting the Day of the week to be adjusted, a ramp time needs to be added. If the Ramp 24hr Time slot is left to "--:--" the schedule will go to the next time Ramp to see if a Ramp time change exists. In some cases, the next Ramp change may be the next day. It is not required to utilize all 8 Ramps per day.

4. Ramp 24Hr Time Setting

Each Ramp can have a time programmed for a specified level adjustment. Each day of the week can have 8 Ramp times assigned. If the Ramp 24hr Time slot is left to "--:--" the schedule will go to the next time Ramp to see if a Ramp time change exists. In some cases, the next Ramp change may be the next day. It is not required to utilize all 8 Ramps per day.

5. Ramp dB Level

This drop-down window allows the user to select the Masking level change desired when the ramp is engaged via the clock. When the Ramp dB level is set to 0dB, it is the same level as the Masking Level A or B's current fader setting. If the Masking A Level is set to -10dB and the Ramp is set to 0dB the Masking A output level will be -10dB from its maximum ASP-MG2240 level. **Example:** If Masking A Level is set to -10dB and the Ramp 1 time is scheduled and the Ramp dB level is programmed to -15dB, when the clock reaches the programmed Ramp day and time the Masking A output level will be -25dB down from the ASP-MG2240 maximum output level. If Ramp 2 is set to -12dB when the clock reaches the assigned time change, the level will change from -25dB to -22dB.

6. Reset

Resets the 24Hr Time and Ramp Level to "--:--" for each day of the week. **Note:** "--:--" is not recognized as a time.

7. Scheduler On/Off

When On, the Masking Level will change in accordance with the day of the week, Ramp 1 - 8 interval and dB level settings. **Note:** The Schedule A or B indicator will blink on the Mixer and Masking pages indicating the scheduler is active.

8. Close

In order to close the 7 Day Schedule page, "Close" must be selected, which will open a "Save Configuration" window. If "Yes" is not selected the programming or changes made to the schedule will be lost.

ASP-MG2240

Owner's Manual

9. System Commissioning Ramp "SCR"

When selecting this tab, a pop up window will appear allowing for a selection of days when ramping will occur. The user can enter from 1 to 14 days. Each day represents 1dB of change. The On/Off will activate the SCR ramp. The Schedule A or B indicator will blink on the Mixer and Masking pages indicating the SCR is active. **Note:** When the SCH is finished or turns to 0 Days the SCR will automatically turn OFF at midnight or at the change from 23:59-00:00. **Note:** 00:00 = 12 Midnight and is start of the new day.



Example: If the Masking A Level is -10dB and you select 14 Days for the ramping to take place, then turn ON the SCR, the Masking A Level is -24dB. The next day the SCR changes to 13 Days and the Masking A output level increases by 1dB making the Masking level -23dB. This will continue until the SCR days reaches 0 Days and the Masking A level reaches -10dB. The SCR will turn OFF automatically.

Using the 24/7 Scheduler & The SCR Together

It is important to understand that the SCR and the 24/7 Scheduler are two different functions. The SCR is used to increase the Masking Level over a longer period of time and is only used one time for initial system commissioning. The 24/7 Scheduler is for the life of the install to adjust the Masking Level by the day and the hour. They can be both active initially for a new installation, however; the SCR always takes priority over the 24/7 Scheduler. When the SCR has completed the commissioning cycle, it automatically turns OFF and the 24/7 Schedule takes over.

Privacy Enhancement

This feature is designed to change the masking level between two spaces when activated. This feature is ideal to use in a medical office, conference room, or any area that needs a more secure speech environment to prevent conversations from being overheard. **Note:** The Privacy Enhancement feature only affects the Masking A & B Levels and NOT the AUX or Mic / Line Levels.

This control port is used to remotely activate the Speech Privacy Enhancement feature. When the "G" and "Engage" are shorted together a series of events happens.

- The front panel Privacy Engaged LED will illuminate Red.
- The masking level will change to the user preset privacy level. See the privacy level fader.
- The port named "To LED" will supply a +10V DCV 100mA voltage to power an indicator sign.

Note: See the application guide on how to use the Privacy Enhancement feature.

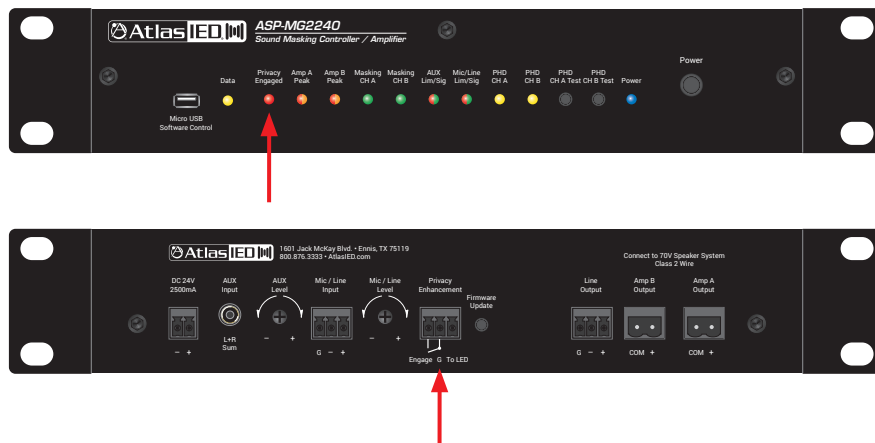

ASP-MG2240

Owner's Manual

Privacy Level Fader

This fader is not active regardless of the position of the fader until the Privacy Enhancement ports "G" and "Engage" are shorted together. The Privacy Enhancement Level fader is "relative" to the Masking A or B Level fader feeding the associated Master Amp A or B level fader. The Privacy level is adjustable (+) or (-) 12dB. When shorted, the Masking A or B Level will change the amplifier masking signal output level by the amount of the Privacy Level fader setting. **Note:** The Privacy Enhancement does not change the AUX or Mic / Line levels. We recommend following the Privacy Enhancement example to understand the masking signal flow and gain structure.



ASP-MG2240

Owner's Manual

Privacy Enhancement Conference Room Example

The following example is an office environment with a conference room in need of additional speech privacy during meetings.

Wired Privacy Signs for Conference Room with ASP-MG2240

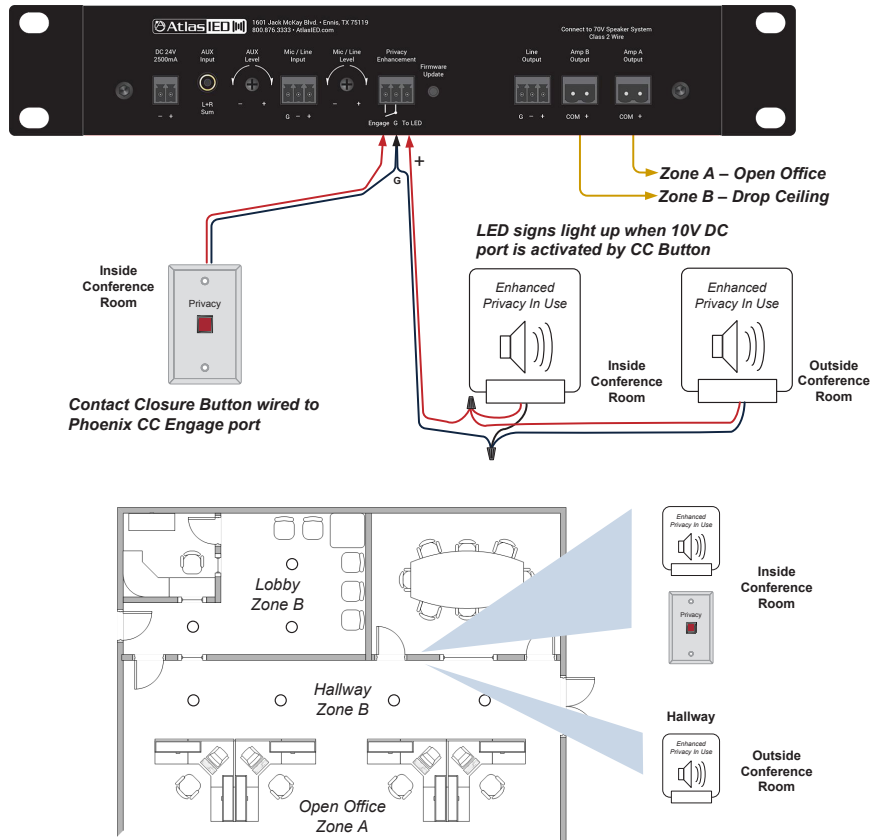

In This Example: Amp A is set up for Open Office acoustics and Amp B is set up for Drop Ceiling acoustics. Amp B is assigned to the Enhanced Privacy Feature and increases Masking Level in Zone B and Lights Signs when Privacy Switch is Engaged.

- The room layout example Zone A is connected to Amp A output. This is for standard open office space sound masking.
- The conference room is located next to the lobby and the hallway and is assigned to Zone B. The Zone B lobby and hallway sound masking levels for normal usage (Non-Privacy Enhancement) are recommended to be close to the sound masking acoustical levels of Zone A.
- During a meeting in the conference room where increased speech privacy is needed, a remote switch is engaged to activate the speech privacy of Zone B. The Enhanced Privacy signs illuminate inside and outside of the conference room indicating the conference room is in Enhanced Speech Privacy mode. The front panel and GUI Privacy Engaged LED / Indicator will also be illuminated.
- Masking Amp B Level fader is set to -10dB and the Master B Level is set to "0" dB on the Mixer Page, 24/7 Scheduler is OFF, so the masking signal level for Amp B output will be -10dB down from the rated output of 20W. The Privacy Level Fader is set to +6dB. The Privacy fader levels are relative to the Masking Levels. When the Privacy Enhancement control port is engaged, the amplified Masking signal on Amp B will increase +6dB in this case, from -10dB to -4dB below the amplifiers 20W rated output. Further explanation: Masking B Level fader = -10dB, Privacy Enhancement fader = +6dB, 24 / Scheduler = 0dB and Master Amp B output level fader = 0dB equating to be -4dB of the maximum amplifiers 20w output. The Privacy level is +6dB relative to the Masking B Level. Refer to the flow chart of the ASP-MG2240 for a detailed view of the signal chain.

ASP-MG2240

Owner's Manual

Using the Push Here Diagnostic Feature

The ASP-MG2240 features a patent pending amplifier self-diagnostic system. The PHD (Push Here Diagnostic) is simple to use and is very effective in running a system diagnostic test to ensure the amplifier has the proper load applied. An incorrect load applied to the amplifier can be a common cause of system failure, especially when using 70.7V loudspeaker systems. There are a few common failure points that can occur during system installation that are listed below.

Common Amplifier Failure Conditions, also see "How to Troubleshoot Your Loudspeaker System if the Limit LED is Illuminating"

1. A short in the loudspeaker wiring.
2. Improper load selection. It is very common when using multiple loudspeakers to have one of the loudspeakers tapped accidentally at 8Ω . This error will put a lot of strain on a 70.7V amplifier and in most cases cause the amplifier to fail within a few days. This kind of error is easy to make, time consuming to find, and costly to fix.
3. Too many loudspeakers attached or the wrong power taps selected. If a 20-watt amp is used in a 70.7V system and it has twenty loudspeakers that are all to be tapped at 1-watt, but five of the loudspeakers are accidentally tapped at 4-watts, 35-watts draw would be applied to the amplifier. While it may work at low levels, as soon as the system needs to be louder the amp will be strained and could fail over time.

There are two known ways to test the loudspeaker system after everything is installed:

1. Measure the loudspeaker system using a true audio frequency impedance meter. This is the best way to see if your loudspeaker system is wired correctly for the amplifier.
2. Run the Push Here Diagnostic test as explained below.

ASP-MG2240

Owner's Manual

Running a Self-Diagnostic Test Using the PHD Feature

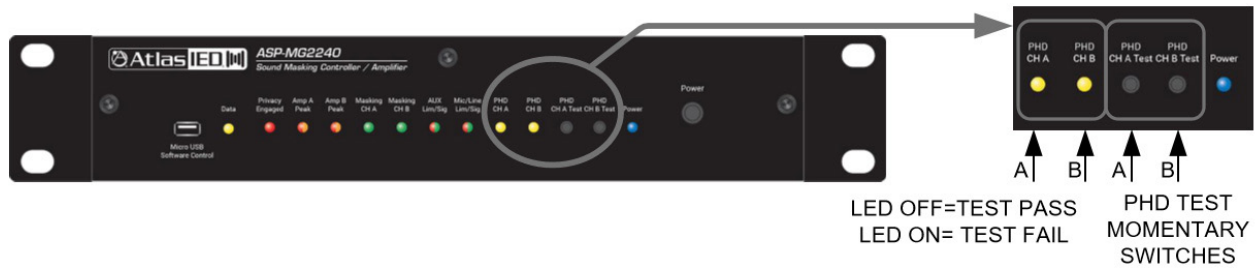

1. Install the ASP-MG2240 masking amplifier, connect the input signals. Turn all levels to minimum.
2. Install the loudspeaker system per the design, double-checking loudspeaker tap settings as they are installed. The total power for all the loudspeakers should NOT exceed the maximum power rating of the amplifier installed. In this case it will be 20-Watts per amplifier.
3. Connect the loudspeaker system to the amplifier. Pay special attention when connecting the loudspeaker leads to ensure connection to the proper terminals on the amplifier.
4. Turn the amplifier On.
5. Before starting the system Diagnostic test, make sure no people are present or near the loudspeakers during the diagnostic test without taking proper precautions for hearing protection as the audible SPL level may be alarming to some people. A 1-watt test tone will be present at each loudspeaker during the test. The audible SPL level will be based on the power tap setting at each loudspeaker and sensitivity specification of the loudspeaker.
6. Locate the activation button on the front panel labeled "PHD CH A Test" or "PHD CH B Test." Press and hold the momentary switch for 5 seconds, then release. A test tone will be audible through the loudspeaker system. If the PHD LED does not illuminate Yellow, the system is properly set up and no errors in the system were found. Continue the installation.

Note: During the initial start of the diagnostic test, the Limit indicator may flash Yellow for a few seconds until an accurate diagnostic reading has been completed; continue to hold the PHD switch in for 5 seconds to ensure the test is complete. After 5 seconds, if the PHD LED is illuminating steadily, stop and read the section "How to Troubleshoot Your Loudspeaker System If the Limit LED is Illuminating."

ASP-MG2240

Owner's Manual

How To Troubleshoot Your Loudspeaker System If The Limit LED Is Illuminating

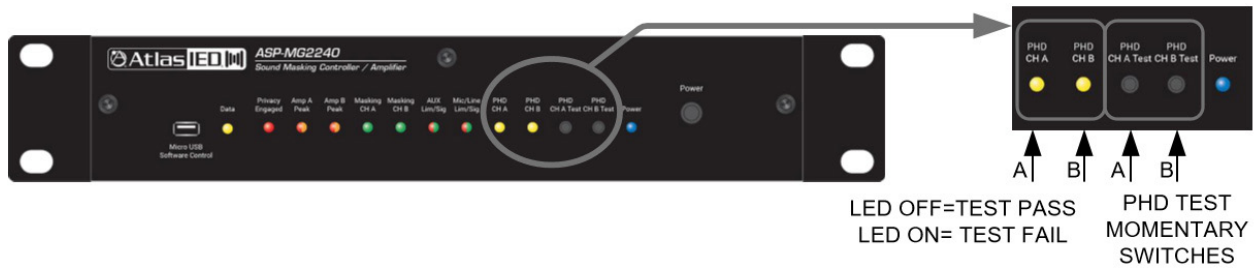

The PHD LED should never be constantly illuminated or damage may occur to the amplifier or sound system. If the PHD LED comes on steadily during use or during the PHD test there are a few common fault conditions to check if using a 70.7V distributed audio system.

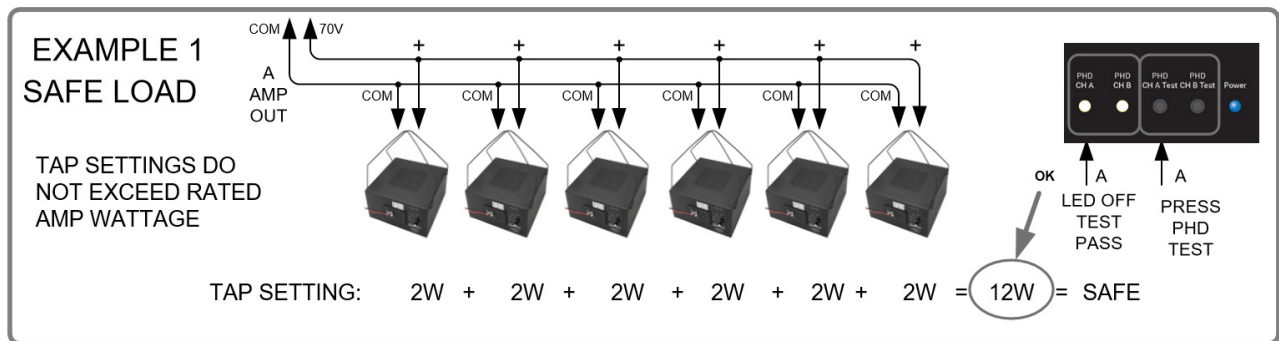

A. Check each loudspeaker setting to make sure it is not set to a 4, 8 or 16 ohm setting. If one loudspeaker is set to one of these settings it will cause a fault condition. A simple and quick way to test this besides visually looking at each loudspeaker is to have a second technician walk the area where the loudspeakers are installed while the PHD test is applied and listen for a loudspeaker that is audibly way louder than the other loudspeakers. The louder loudspeaker most likely will be incorrectly tapped and the cause of the fault. **Note:** Always take proper hearing precautions.

ASP-MG2240

Owner's Manual

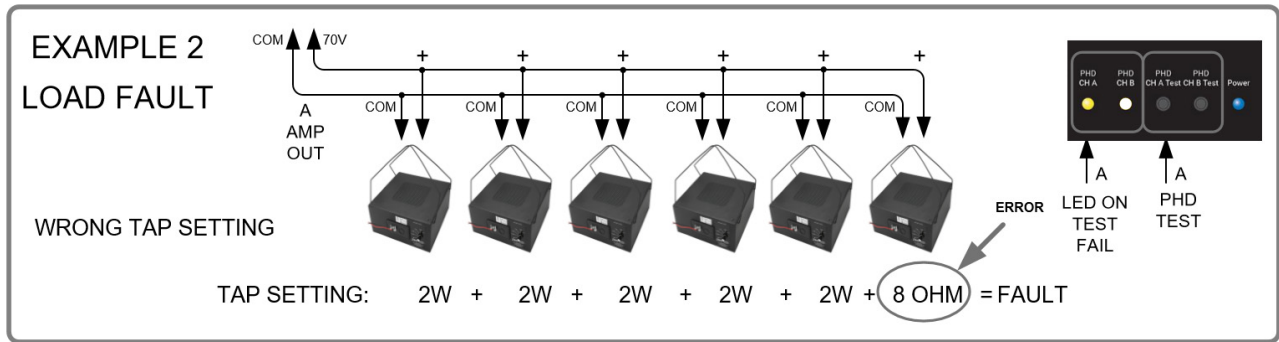

B. Check each loudspeaker to be sure the load tap is set to the correct power setting. The total power tap selected of all the loudspeakers combined should not exceed the amplifier's maximum power rating or a fault will occur.

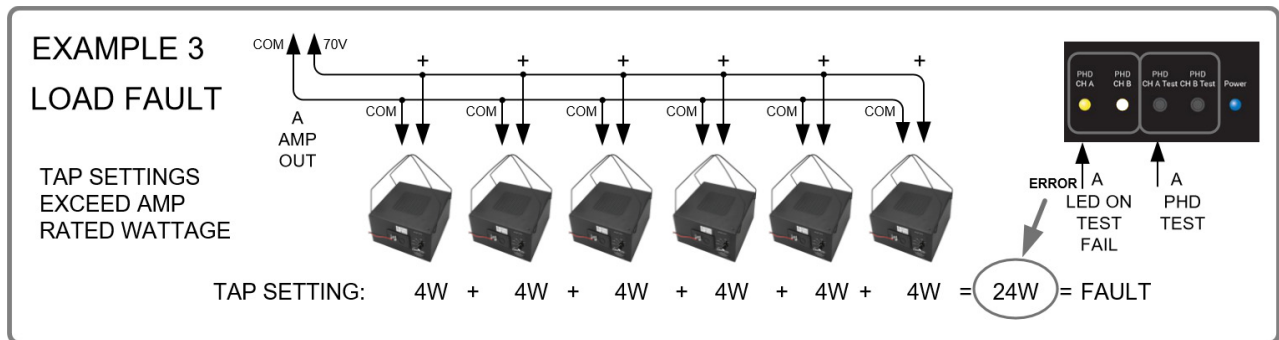

C. If the first two checks do not identify a problem, there is probably a short in the wiring of the loudspeaker system. Common causes include staples through the wire or the wire cut by metal conduit causing a short to ground.

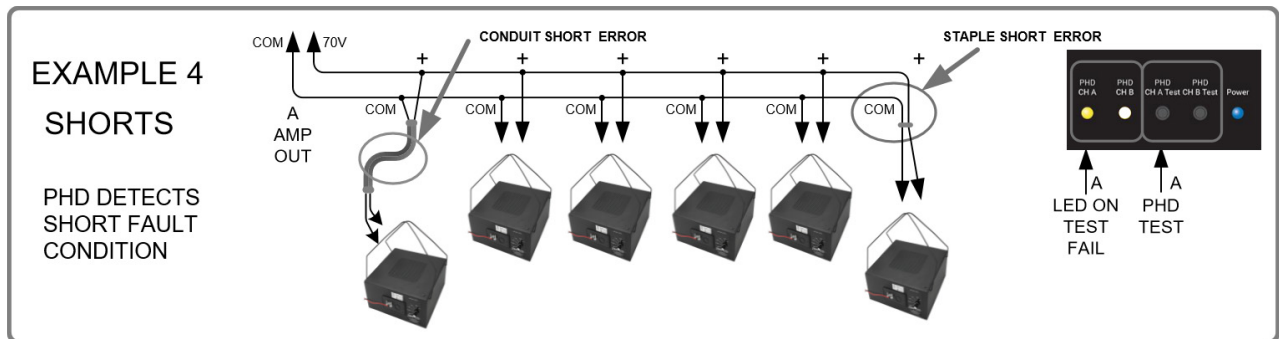

ASP-MG2240

Owner's Manual

Application Examples

ASP-MG2240 Masking in 2 Zone Example

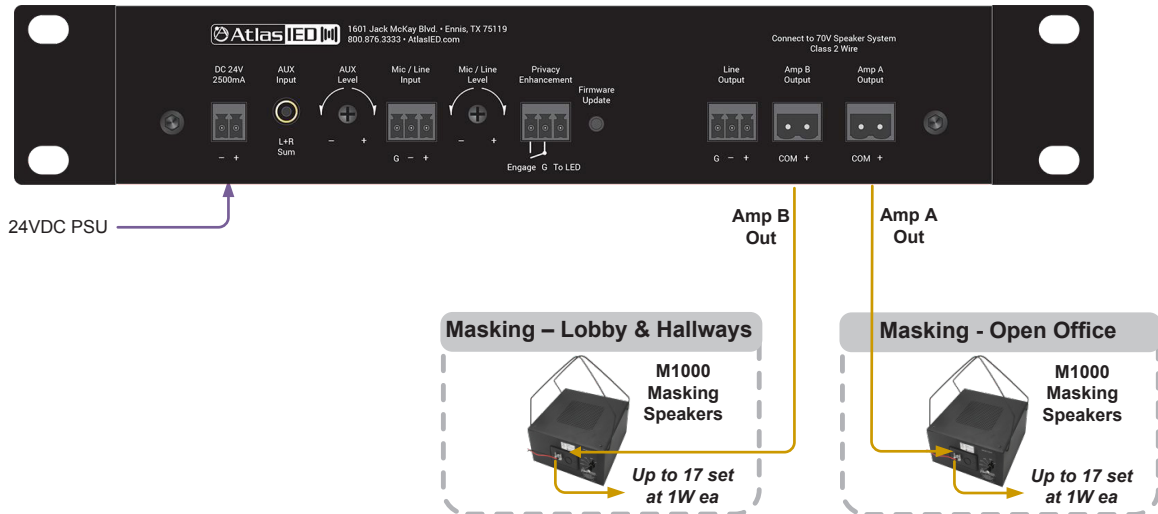

In This Example: Amp A is set up for Open Office acoustics and Amp B is set up for Drop Ceiling acoustics.

ASP-MG2240 Masking in 3 Zone Example

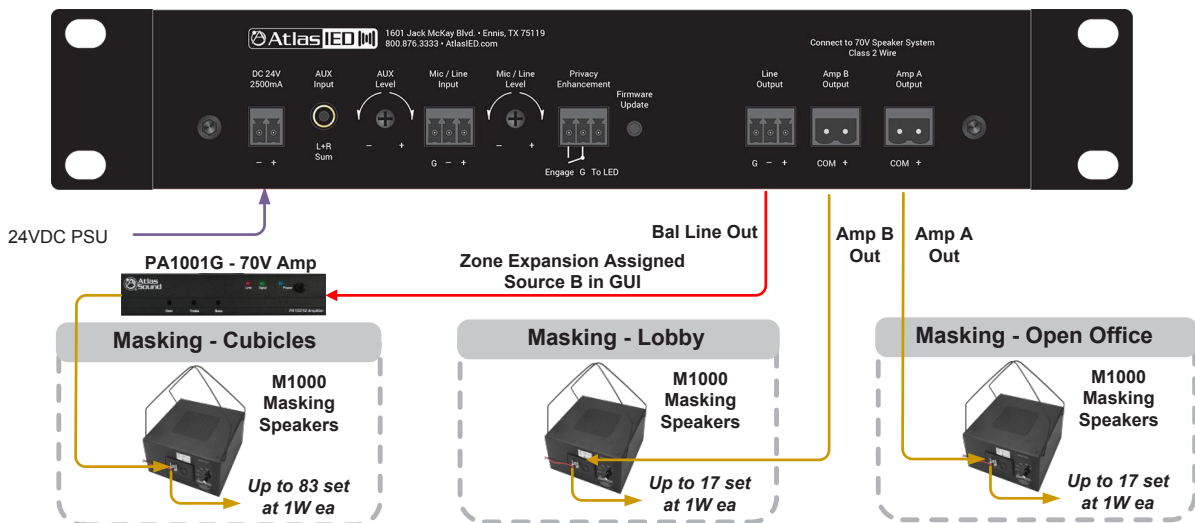

In This Example: Amp A is set up for Open Office acoustics and Amp B is set up for Drop Ceiling acoustics. Amp B is assigned to the Cubicles Zone because it also has a Drop Ceiling.

ASP-MG2240

Owner's Manual

Application Examples

ASP-MG2240 Masking in 2 Zone Example with BGM and Paging

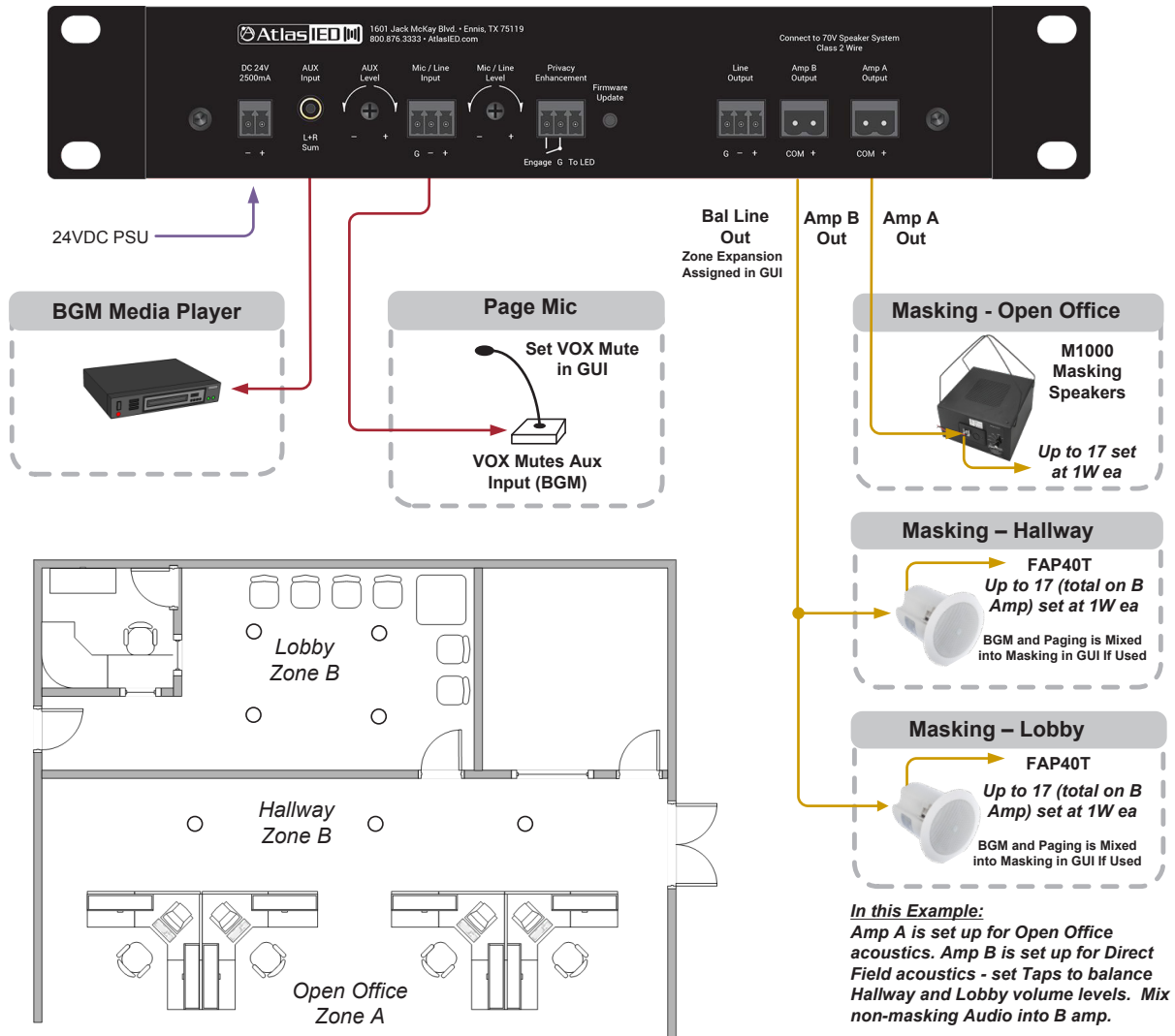

ASP-MG2240

Owner's Manual

Block Diagram

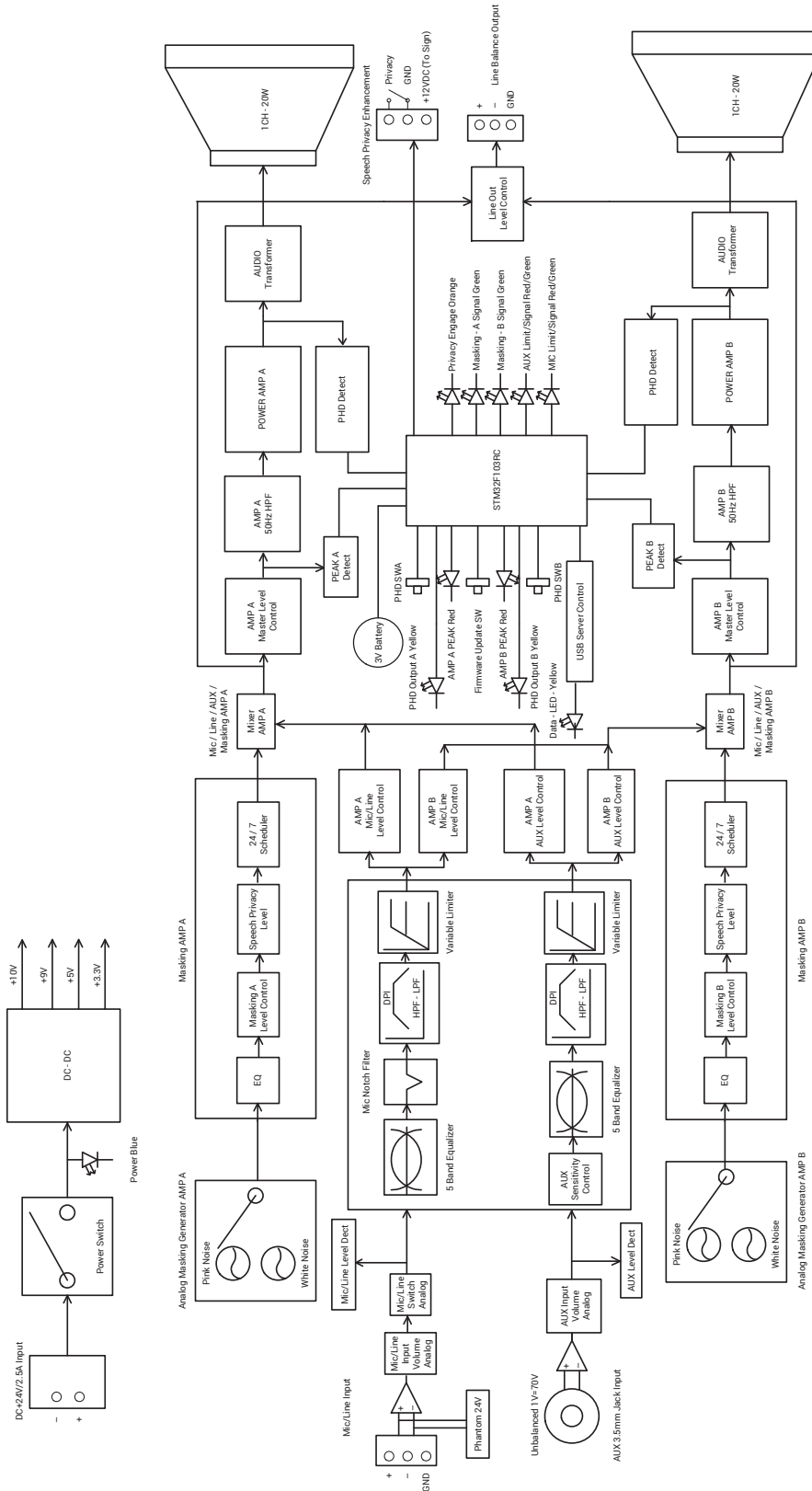

ASP-MG2240

Owner's Manual

Rack Mounting the ASP-MG2240

The ASP-MG2240 is designed to mount in standard 19" rack or an AtlasIED half width rack. Included in the carton is a rack mount kit that will allow the ASP-MG2240 to be rack mounted by itself, or with another AtlasIED half width rack product. The rack mount kit is also compatible with AtlasIED models PA702, PA1001G, MA40G, MA60G, PA40G, PA60G, DPA102PM, AP-S15HR, and AP-S15RTHR.

Kit Contains

- Qty 2 Rack Ears
- Qty 4 Rack Ear Chassis Screws
- Qty 1 Rack Extension Plate for Single Unit Mounting
- Qty 2 M4 x 10mm Pan Head Black Screws to Combine Extension Plate to Rack Ear
- Qty 2 M4 Hex Nuts for Screws to Secure Screw to Extension Plate and Rack Ear
- Qty 2 Top Joiner Plates
- Qty 8 4-40 x 3/8 Flat Head Black Screws to Secure Top Joiner Plate
- Qty 1 Front Panel Joiner Plate
- Qty 2 4-40 x 3/8 Flat Head Black Screws to Secure Front Panel Joiner Plate

Configuration 1 - Mounting a Single 1 RU Model

1. Remove amplifier from electrical source.
2. Remove the four feet.
3. Align and secure the chassis extension plate to a rack mount ear with the enclosed screws and nuts.
4. Locate the two open holes on each side of the amp located towards the front panel.
5. Align the enclosed rack mount ear and extension assembly to the chassis holes located in step 4.
6. Use the enclosed chassis screws to attach the rack ears and extension assembly to the chassis. Secure firmly, do not over tighten. Repeat step for opposite chassis side.
7. Disregard extra pieces.
8. Ready for rack installation. **Note:** It is important the amplifiers have the proper clearance around it for proper heat dissipation. Always allow at least 1.75" around the amplifier for to assure safe operation. Never mount an amplifier in an enclosed air tight rack. All racks must have air vents on all sides or forced air cooling to assure proper heat dissipation.

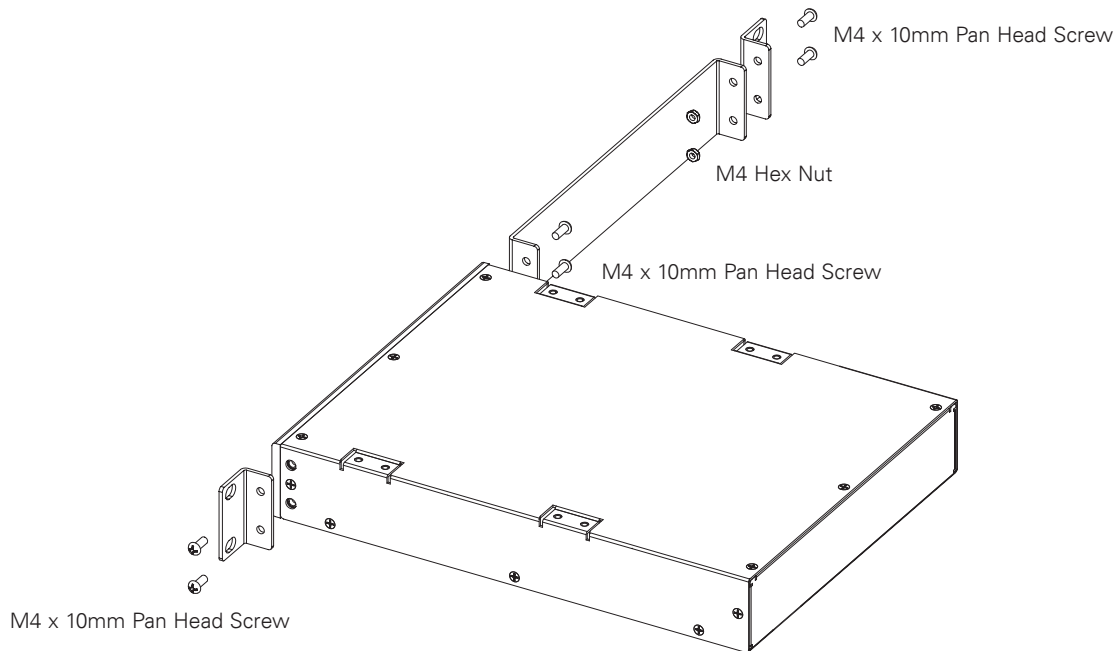

ASP-MG2240

Owner's Manual

Configuration 2 - Mounting 2 1RU Models

Note: Not all 1RU half rack models can be joined next to each other. The following combinations can be joined.

- A. PA1001G and PA1001G Only
 - B. PA702 and PA702 Only
 - C. ASP-MG2240, DPA102PM, MA40G, MA60G, PA40G, PA60G, AP-S15HR, and AP-S15RTHR are interchangeable. Call AtlasIED for other models not listed.
1. Remove amplifier from electrical source.
 2. Remove the four feet.
 3. Align and secure two chassis joiner plates with the enclosed screws to the top of units. **Note:** Must install both plates, one towards the front and one towards the back.
 4. Locate the two open holes on each side of the amp located towards the front panel.
 5. Align the enclosed rack mount ear to the chassis holes located in step 2.
 6. Use the enclosed chassis screws to attach the rack ears to the chassis. Secure firmly, do not over tighten. Repeat step for opposite chassis side.
 7. Install the front panel joiner plate using the two 4-40 x 3/8 flat head black screws. **Note:** The front panel joiner plate can be removed after the unit is installed in the rack.
 8. Disregard extra pieces.
 9. Ready for rack installation. **Note:** It is important the amplifiers have the proper clearance around it for proper heat dissipation. Always allow at least 1.75" around the amplifier for to assure safe operation. Never mount an amplifier in an enclosed air tight rack. All racks must have air vents on all sides or forced air cooling to assure proper heat dissipation.

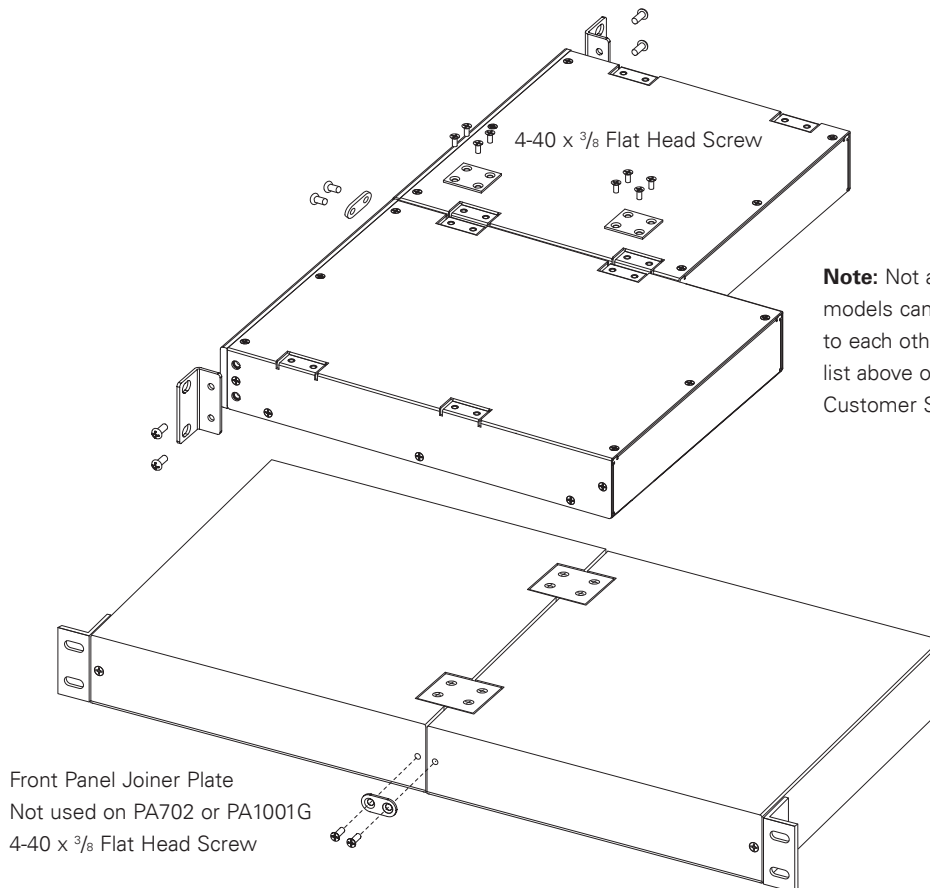

Note: Not all 1RU half rack models can be joined next to each other. Refer to the list above or call AtlasIED Customer Service.

ASP-MG2240

Owner's Manual

System	
Type	Sound Masking Controller and Amplifier
Power Supply Type	External Inline 24V 2500mA Global
Amp Topology	Class D
Number of Fixed Inputs	2
Accessory Inputs	0
DSP Internal	Yes
Network	USB Interface
Optional Accessory Card Slot	NA
Output Power (Note 1)	
2 CH	30W x 2 into 250Ω Load @ 70V (Note: A Lower Impedance Will Cause the Amp to Go Into Protect)
Factory Default Settings (As Shipped)	
Amplifier Configuration	2 CH
Level Controls Assignment	Masking Fixed via Factory Preset, Mic and AUX Adjustable Rear Panel
I/O Matrix	Masking Generator 1 = Amp Output 1, Masking Generator 2 = Amp Output 2 Mic and AUX Routed to Output 1 and 2
Level Position	DSP Set to -10dBu, Rear Panel Level Control Set to 50%
EQ and Filters	Masking EQ - Customer filters for Above Ceiling Preset Mic = 120Hz HPF, AUX = 100Hz HPF
Limiter	0dB (Max Power)
GPIO Control Ports (Rear Panel)	Speech Privacy Engage, Privacy Sign Output
Auto Power Down (APD)	NA
24Hr / 7-Day Scheduler	Off
System Commissioning Ramp	Off
Inputs	
Input Quantity	2
Input Type (Line Balanced or Unbalanced)	Mic / Line Balanced and AUX L & R Summed Unbalanced
Input Impedance	40kΩ
Input Sensitivity	Mic 5mV, Line 500mV, AUX Variable 1V - 316mV
Maximum Input Level dBu and Vrms	Mic 50mV, Line 2V, AUX 2V
Input Connectors Type	Mic / Line 3.5mm Euro Block, AUX 3.5mm
Accessory Slot	NA
Level Control	
Rear Panel Manual	Mic / Line and AUX
GUI Control	Mic / Line, AUX, Masking
Status Indicators - Front Panel and GUI	
Power	Blue Indicator
Standby (Remote Turn ON)	NA
Output Signal	Green, CH 1/2
Output Peak Fault CH A	Red
Output Peak Fault CH B	Red
PHD Fault CH A	Yellow
PHD Fault CH B	Yellow
AUX Signal / Limit	Green
Mic / Line Signal / Limit	Green
Masking A	Green
Masking B	Green
Privacy Engage	Red

ASP-MG2240

Owner's Manual

Front Panel Features	
Power Switch	Push, Latching
Push Here Diagnostics (PHD) Switch	Push, Momentary
USB	Micro USB
Rear Panel Features	
Power Input	24V DC, 2500mA, 2 Position, 3.5mm Euro Block, (Phoenix)
AUX Input	3.5mm Jack
Mic / Line	3 Position, 3.5mm Euro Block, (Phoenix)
AUX Level	Rotary Potentiometer
Mic / Line Level	Rotary Potentiometer
Privacy Engage	3 Position, 3.5mm Euro Block, (Phoenix)
Line Output	3 Position, 3.5mm Euro Block, (Phoenix)
CH A Amplifier Output	2 Position, 5.08mm Euro Block, (Phoenix)
CH B Amplifier Output	2 Position, 5.08mm Euro Block, (Phoenix)
Firmware Update Switch	Push, Momentary
DSP Features and Elements	
Scheduler	Separate 24Hr / 7-Day Scheduler for Masking A & B Outputs, 7 Day Battery Clock Back Up
Level Control	Level and Mic / Line, AUX, Masking A and B, Line Out
System Commissioning Ramp	Separate Commissioning Ramps for Masking A & B Outputs, 7 Day Battery Clock Back Up
Masking Noise	Pink and White Noise Analog Generators
Presets	10 Total Factory Presets - Open Ceiling, Above Ceiling, Below Floor, Factory 6 Available For Customer
Hi and Low Pass Filters	Mic / Line, AUX, Masking A and B
EQ	AUX and Line - 5 Parametric Filters, Masking 1/3 Octave
Delay	NA
Limiter	Mic / Line 0db - 15dB of Assignable Limiting
DSP Frequency Type	24bit
Interface Control Ports	
USB	Micro USB, ASP-MG2240 Software Required
Ethernet	No
WiFi	No
Bluetooth	No
GPIO Ports	
Location	Rear
GPIO Ports	Qty 1
Connection	Euro Block PHX Type 3.5mm, 3 Pins, Ground, +10VDC (Output After Engaged), C1
Functions	Speech Privacy Engage, Privacy Sign Output
Line Output	
Output Quantity	1
Input Type (Line Balanced or Unbalanced)	Balanced
Output Impedance	150Ω
Maximum Output Level dBu and Vrms	2V
Output Connector Type	3 Position, 3.5mm Euro Block, (Phoenix)

ASP-MG2240

Owner's Manual

Output Terminals (Speaker)			
Output Connectors Type	5.08mm Euro Block, (Phoenix)		
Number of Terminals	2		
Output Connectors Fixed or Removable	Removable		
Wire Size	14 AWG		
Terminal Spacing	5.08mm		
Current Rating	12A per Terminal		
Wire Class Required	Class 2		
Cooling			
Convection	Yes		
Electrical Specifications (General)			
Masking Generator	Qty 2 Circuits Analog		
Total Harmonic Distortion 1kHz and 1dB Below Rated Power	Typical, .2%		
Frequency Response	50Hz - 15kHz (DSP Filters Set to Flat)		
Signal to Noise Ratio	>90dB Below Rated Output (A-weighted)		
Damping Factor (20Hz to 400Hz)	NA		
Slew Rate	NA		
Crosstalk	69dB @ 1KHz		
Protection	Hi / Low Input Voltage, Thermal, Short, Over Current		
Max Output Peak Voltage	70V		
File Storage	Recall or Save to Device, Recall or Save to Computer		
AC Power Requirements			
Operating Voltage	External Supply 110V-230V, 50/60Hz		
Mains Interface	IEC C7 Receptacle to Inline Power Supply, To Amp - 24V DC Output 2 Position, 3.5mm Euro Block, (Phoenix)		
Power Cord (Included)	2m, NEMA 1-15P Standard USA 2 Pin Plug to IEC C7 Receptacle with 18/2 SPT-2 Black Rated up to 10A 100V to 240V		
Minimum Power-Up Voltage	100V		
Maximum Operating Voltage	240V		
Recommended AC Mains Current Requirements	3A		
Power Consumption and Current Draw (Note 4)	Amps	Watts	BTU
Standby / APD Mode	NA	NA	NA
Idle Active / On	72mA	4.4W	15 BTU
Average Power, All Channels Driven (Note 2)	275mA	19W	30 BTU
Max Power, All Channels Driven (Note 3)	908mA	67W	92 BTU
Dimensions and Weight			
Rack Mount Requirements	1 RU, 19"		
Dimensions - Unit	W 10.5" x H 1.75" x D 11.25" (266mm x 44mm x 286mm)		
Dimensions - Shipping	W 11" x H 5.5" x D 13.5" (279mm x 140mm x 344mm)		
Weight - Unit	5.75 lbs. (2.6kg)		
Weight - Shipping	8.8 lbs (4kg)		
Agency Approvals			
North America Agency	UL, TUV, GMA (Power Supply)		
Testing Standard North America	60065		
FCC Class A (Conducted and Radiated Emissions)	Part 15 of the FCC Rules		
RoHS / WEEE Compliant	Yes		
CE	Yes		

ASP-MG2240

Owner's Manual

Optional Accessories

ASP-MG2240S

Wired Enhanced Privacy Sign

NOTES:

1. Power level measurement is define as follows: 1Hz sine AUX, line or mic inputs.
2. Average Power is defined as Pink Noise input signal applied to achieve 1/4 of the power rating.
3. Max Power is defined as 1 KHz input signal applied to achieve the maximum power output before clipping into a specified load.
4. BTU is calculated by the AC Mains Power consumed minus the total power output measured at the specified load and condition, multiplied by 3.412.
Example: 785 Watts from the AC Source - 600 Watts Total Output power = 185 x 3.412 = 631 BTU

Limited Warranty

All products manufactured by AtlasIED are warranted to the original dealer/installer, industrial or commercial purchaser to be free from defects in material and workmanship and to be in compliance with our published specifications, if any. This warranty shall extend from the date of purchase for a period of three years on all AtlasIED products, including SOUNDOLIER brand, and ATLAS SOUND brand products except as follows: one year on electronics and control systems; one year on replacement parts; and one year on Musician Series stands and related accessories. Additionally, fuses and lamps carry no warranty. AtlasIED will solely at its discretion, replace at no charge or repair free of charge defective parts or products when the product has been applied and used in accordance with our published operation and installation instructions. We will not be responsible for defects caused by improper storage, misuse (including failure to provide reasonable and necessary maintenance), accident, abnormal atmospheres, water immersion, lightning discharge, or malfunctions when products have been modified or operated in excess of rated power, altered, serviced or installed in other than a workman like manner. The original sales invoice should be retained as evidence of purchase under the terms of this warranty. All warranty returns must comply with our returns policy set forth below. When products returned to AtlasIED do not qualify for repair or replacement under our warranty, repairs may be performed at prevailing costs for material and labor unless there is included with the returned product(s) a written request for an estimate of repair costs before any nonwarranty work is performed. In the event of replacement or upon completion of repairs, return shipment will be made with the transportation charges collect.

EXCEPT TO THE EXTENT THAT APPLICABLE LAW PREVENTS THE LIMITATION OF CONSEQUENTIAL DAMAGES FOR PERSONAL INJURY, ATLASIED SHALL NOT BE LIABLE IN TORT OR CONTRACT FOR ANY DIRECT, CONSEQUENTIAL OR INCIDENTAL LOSS OR DAMAGE ARISING OUT OF THE INSTALLATION, USE OR INABILITY TO USE THE PRODUCTS. THE ABOVE WARRANTY IS IN LIEU OF ALL OTHER WARRANTIES INCLUDING BUT NOT LIMITED TO WARRANTIES OF MERCHANTABILITY AND FITNESS FOR A PARTICULAR PURPOSE.

AtlasIED does not assume, or does it authorize any other person to assume or extend on its behalf, any other warranty, obligation, or liability. This warranty gives you specific legal rights and you may have other rights which vary from state to state.

Service

Should your ASP-MG2240 require service, please contact the AtlasIED warranty department at 1-877-689-8055, ext. 277 or atlasied.com/support to obtain an RA number.

AtlasIED Tech Support can be reached at 1-800-876-3333 or atlasied.com/support

Visit our website at www.AtlasIED.com to see other Atlas products.