



# BRH50M

## Broadcast Headset

Shure online user guide for BRH50M broadcast headset.  
Version: 2 (2019-G)

# Table of Contents



<b>BRH50M Broadcast Headset</b>	<b>3</b>	<b>Wearing the Headset</b>	<b>5</b>
<b>SAFETY PRECAUTIONS</b>	<b>3</b>	<b>Replacement Parts</b>	<b>6</b>
CAUTION	3	<b>Model Variations</b>	<b>7</b>
WARNING	3	BRH Broadcast Cable Accessories	7
WARNING	3	<b>Specifications</b>	<b>9</b>
<b>BRH50M Premium Dual-Sided Broadcast Headset</b>	<b>3</b>	Find More Information Online	10
Features	4	Performance Characteristics	11
<b>Care and Maintenance</b>	<b>4</b>	<b>Certifications</b>	<b>11</b>
<b>Detachable Cable</b>	<b>4</b>	<b>LIMITED WARRANTY</b>	<b>12</b>
		Service Centers	13

# BRH50M

## Broadcast Headset

### SAFETY PRECAUTIONS

The possible results of incorrect use are marked by one of the two symbols—"WARNING" and "CAUTION"—depending on the imminence of the danger and the severity of the damage.

	WARNING: Ignoring these warnings may cause severe injury or death as a result of incorrect operation.
	CAUTION: Ignoring these cautions may cause moderate injury or property damage as a result of incorrect operation.

### CAUTION

- Never disassemble or modify the device, as failures may result.
- Do not subject to extreme force and do not pull on the cable or failures may result.
- Keep the product dry and avoid exposure to extreme temperatures and humidity.

### WARNING

- If water or other foreign objects enter the inside of the device, fire or electric shock may result.
- Do not attempt to modify this product. Doing so could result in personal injury and/or product failure.

*This device is able to produce sound volume higher than 85 dB SPL. Please check your maximum allowed continuous noise exposure level based on your national employment protection requirements.*

### WARNING

**LISTENING TO AUDIO AT EXCESSIVE VOLUMES CAN CAUSE PERMANENT HEARING DAMAGE. USE AS LOW A VOLUME AS POSSIBLE.** Over exposure to excessive sound levels can damage your ears resulting in permanent noise-induced hearing loss (NIHL). Please use the following guidelines established by the Occupational Safety Health Administration (OSHA) on maximum time exposure to sound pressure levels before hearing damage occurs.

<b>90 dB SPL</b> at 8 hours	<b>95 dB SPL</b> at 4 hours	<b>100 dB SPL</b> at 2 hours	<b>105 dB SPL</b> at 1 hour
<b>110 dB SPL</b> at ½ hour	<b>115 dB SPL</b> at 15 minutes	<b>120 dB SPL</b> Avoid or damage may occur	

# BRH50M Premium Dual-Sided Broadcast Headset

The BRH50M Broadcast Headset is developed especially for on-camera use in broadcast and media production environments. Supra-aural design with replaceable earpads provides long-wearing comfort and good isolation. The dynamic, supercardioid microphone delivers natural, highly intelligible vocal reproduction, and pivots 270 degrees for left or right side wear. A variety of detachable cables enables connection to a wide range of devices for a lifetime of use.

## Features

- Closed-back, supra-aural design with soft, replaceable earpads provides long-wearing comfort and good isolation
- Dynamic microphone delivers natural, highly intelligible vocal reproduction with supercardioid polar pattern and frequency response optimized for communication in loud environments
- Ergonomic, ultra-lightweight design with split-frame adjustable, padded headband for long wearing comfort
- Rigid boom microphone pivots 270 degrees for left or right side wear
- A variety of cables are available to connect to a wide range of devices
- User-replaceable cable, earpads and windscreen provided for a long product life
- Legendary Shure durability to withstand the rigors of professional use

## Care and Maintenance

Clean using a soft, damp cloth.

**CAUTION:** Do not use cleansers that contain solvents. Keep liquid and foreign objects out of the driver openings.

## Detachable Cable

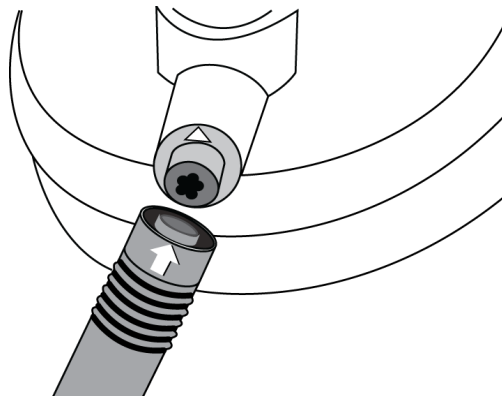

*Attach the cable by aligning the arrows and pressing firmly into place until locked.*

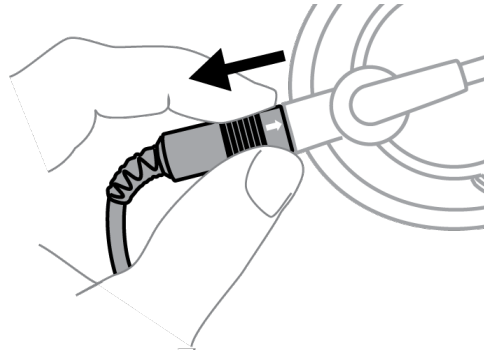

*Pull on the knurled collar to disengage lock and remove cable.*

## Wearing the Headset

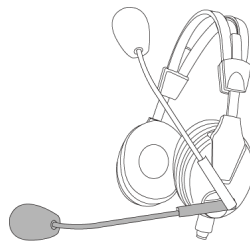

The boom swivel allows the headset to be worn with the microphone on the left or the right side.

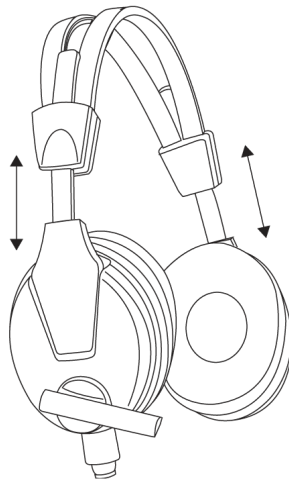
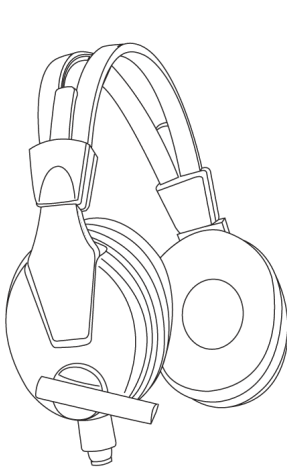

Adjust the headband for a comfortable fit.

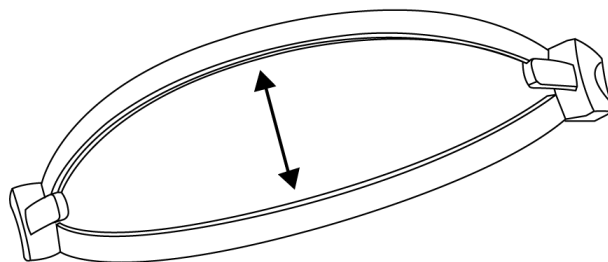

Increase headband width for additional head grip.

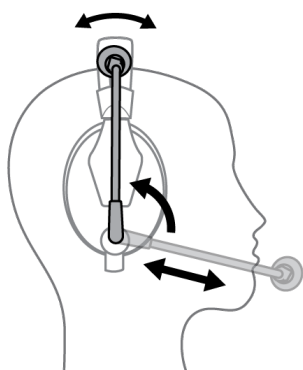

Slide the boom to position the microphone within 13 mm (1/2 inch) of the right corner of your mouth.

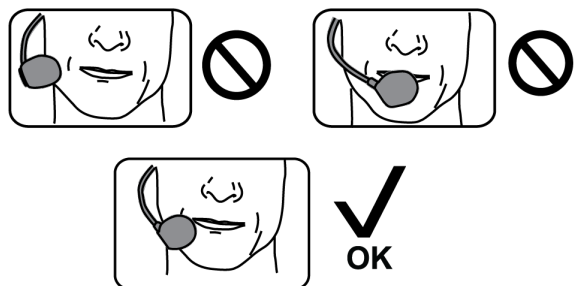

To avoid "popping" or other breath noise, do not place directly in front of mouth.

## Replacement Parts

Replacement windscreen for BRH50M	BCAWS2
1 pair of replacement earcup pads for BRH50M	BCAEC50
Replacement cable for BRH headset - terminates to XLR3M and 1/4 in. Neutrik connectors (7.5 ft. length)	BCASCA-NXLR3QI

Replacement cable for BRH headset - terminates to XLR3M and 1/4 in. Neutrik connectors (25 ft. length)	BCASCA-NXLR3QI-25
Replacement cable for BRH headset - terminates to XLR4M Neutrik connector (7.5 ft. length)	BCASCA-NXLR4
Replacement cable for BRH headset - terminates to XLR5M Neutrik connector (7.5 ft. length)	BCASCA-NXLR5
Replacement cable for BRH headset - terminates to XLR4F Neutrik connector (7.5 ft. length)	BCASCA-NXLR4-FEM
Replacement cable for BRH headset - unterminated (bare whip) (6.5 ft. length)	BCASCA-1

## Model Variations

<b>BRH50M Dual-Sided Broadcast Headset</b>	BRH50M
<b>BRH50M Dual-Sided Broadcast Headset (without cable)</b>	BRH50M-LC

## BRH Broadcast Cable Accessories

The following tables describe wiring for BRH detachable cables. All BRH detachable cables contain six conductors with discrete termination at the Shure 6-pin connector that plugs into the headset. For pre-terminated cables, conductors (and signal) are tied to common contacts at the other end of the cable where shown.

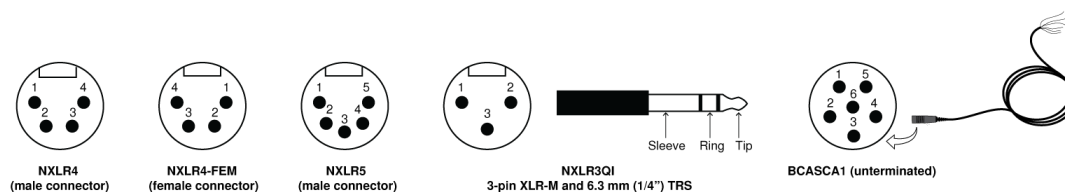

Connector Pin Diagram

### BCASCA-NXLR4 (male connector)

4-Pin XLR-M	Signal	Wire	6-Pin Headset Connector
1	Mic -	Black	2
2	Mic +	Red	1
3	Mic Ground	Shield (uncoated)	3
	Headphone Audio Ground	White	6

4-Pin XLR-M	Signal	Wire	6-Pin Headset Connector
4	Headphone Audio 1	Orange	4
	<b>Headphone Audio 2 (boom side)</b>	Green	5

## BCASCA-NXLR4-FEM (female connector)

4-Pin XLR-F	Signal	Wire	6-Pin Headset Connector
1	Mic -	Black	2
	<b>Mic Ground</b>	Shield (uncoated)	3
2	Mic +	Red	1
3	Headphone Audio Ground	White	6
4 (thru 47uF cap)	Headphone Audio 1	Orange	4
	<b>Headphone Audio 2 (boom side)</b>	Green	5

## BCASCA-NXLR5 (male connector)

5-Pin XLR-M	Signal	Wire	6-Pin Headset Connector
1	Mic -	Black	2
2	Mic +	Red	1
3	Mic Ground	Shield (uncoated)	3
	<b>Headphone Audio Ground</b>	White	6
4	Headphone Audio 2 (boom side)	Green	5
5	Headphone Audio 1	Orange	4

## BCASCA-NXLR3QI

Connector	Contact	Signal	Wire	6-Pin Headset Connector
3-Pin XLR-M	1	Mic Ground	Shield (uncoated)	3
	2	Mic +	Red	1
	3	Mic -	Black	2
6.3 mm (1/4") TRS	Sleeve	Headphone Audio Ground	White	6
	Tip	Headphone Audio 2 (boom side)	Green	5
	Ring	Headphone Audio 1	Orange	4



## BCASCA1 (unterminated)

Signal	Wire	6-Pin Headset Connector
Mic +	Red	1
Mic -	Black	2
Mic Ground	Shield (uncoated)	3
Headphone Audio 1	Orange	4
Headphone Audio 2 (boom side)	Green	5
Headphone Audio Ground	White	6

## Specifications

### Weight

208 g (7.4 oz.), without cable

### Environmental Conditions

Operating Temperature	18° to 60° C (0° to 140° F)
Storage Temperature	-29° to 74° C (-29° to 165° F)
Relative Humidity	0 to 95%

## Microphone

### Type

Dynamic, Neodymium magnet

### Polar Pattern

Supercardioid

### Frequency Response

40 to 16,000 Hz

### Output Impedance

250  $\Omega$

### Sensitivity

*at 1 kHz, open circuit voltage*

-60.0 dBV/Pa\* (1.0 mV)

### Polarity

Positive pressure on diaphragm produces positive voltage on pin 1 (red wire) with respect to pin 2 (black wire).

## Headphone

### Transducer Type

Dynamic, Neodymium magnet

### Driver Size

40 mm

### Frequency Response

20 to 20,000 Hz

### Sensitivity

@ 1 kHz

110 dB SPL/mW

### Impedance

@ 1 kHz

300  $\Omega$

### Maximum Input Power

1000 mW

## Find More Information Online

For more information, visit <http://www.shure.com>

# Performance Characteristics

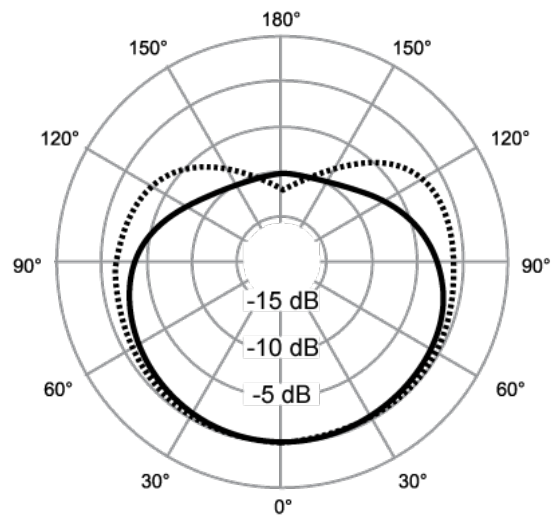
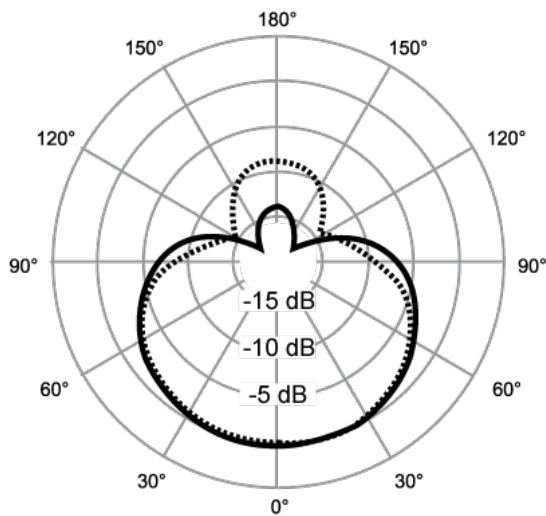
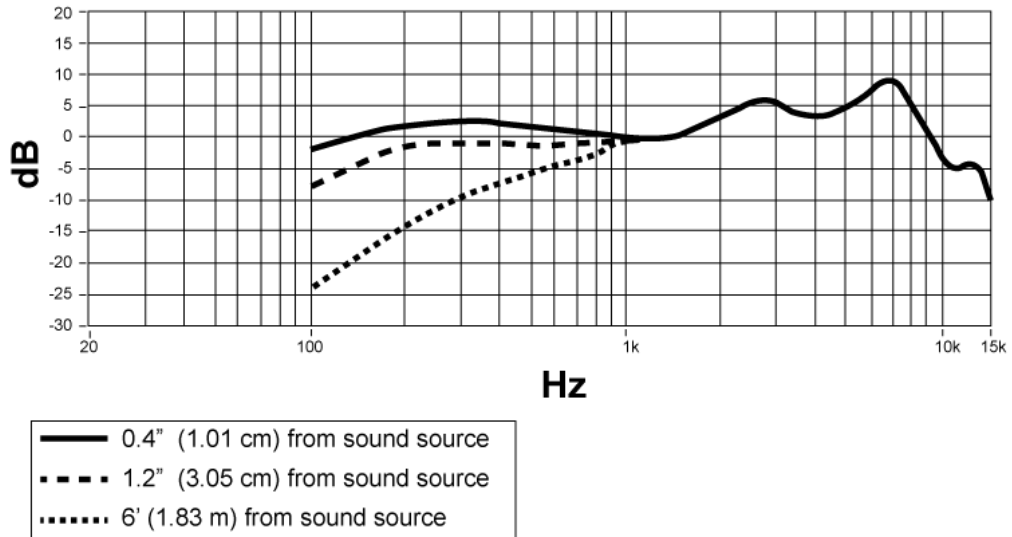

..... 500 Hz  
 ——— 1,000 Hz

———— 2,000 Hz  
 ..... 4,000 Hz



# Certifications

This product meets the Essential Requirements of all relevant European directives and is eligible for CE marking.

The CE Declaration of Conformity can be obtained from: [www.shure.com/europe/compliance](http://www.shure.com/europe/compliance)

Authorized European representative:

Shure Europe GmbH

Headquarters Europe, Middle East & Africa

Department: EMEA Approval

Jakob-Dieffenbacher-Str. 12

75031 Eppingen, Germany

Phone: +49-7262-92 49 0

Fax: +49-7262-92 49 11 4

Email: [info@shure.de](mailto:info@shure.de)

---

## LIMITED WARRANTY

Shure Incorporated ("Shure") hereby warrants to the original consumer purchaser only that, except as otherwise specified below, this product will be free in normal use of any defects in materials and workmanship for a period of two (2) years from the consumer's original date of purchase directly from Shure or from a Shure-authorized reseller.

Any rechargeable batteries contained in or packaged with this product are so warranted for a period of one (1) year from the consumer's original date of purchase. However, rechargeable batteries are consumable and their capacity will be reduced over time based on temperature, amount of time in storage, charging cycles, and other factors; hence reduction in battery capacity does not constitute a defect in material or workmanship.

At its sole option, Shure will repair or replace the defective product and promptly return it to you. In order for this warranty to be valid, the consumer must, at the time the product is returned, provide proof of purchase in the form of the original purchase receipt directly from Shure or from a Shure-authorized reseller. If Shure elects to replace the defective product, then Shure reserves the right to replace the defective product with another product of the same model or a model of at least comparable quality and features in Shure's sole determination.

If you believe this product is defective within the warranty period, carefully repack the unit, insure it and return it with proof of purchase, postage prepaid, to Shure Incorporated, Attention: Service Department, at the address below.

Outside of the United States, return the product to your dealer or Authorized Service Center. Addresses are listed on [www.Shure.com](http://www.Shure.com) or can be obtained by contacting Shure at the address listed below.

This warranty is not transferable. This warranty does not apply in cases of abuse or misuse of the product, use contrary to Shure's instruction, ordinary wear and tear, an act of God, negligent use, purchase from a party other than Shure or a Shure-authorized reseller, unauthorized repair, or modification of the product.

ALL IMPLIED WARRANTIES OF MERCHANTABILITY OR FITNESS FOR A PARTICULAR PURPOSE ARE HEREBY DISCLAIMED TO THE EXTENT PERMITTED UNDER APPLICABLE LAWS AND, TO THE EXTENT NOT PERMITTED, ARE HEREBY LIMITED TO THE DURATION AND TERMS OF THIS WARRANTY. SHURE ALSO HEREBY DISCLAIMS ALL LIABILITY FOR INCIDENTAL, SPECIAL, OR CONSEQUENTIAL DAMAGES.

Some states do not allow limitations on how long an implied warranty lasts, or the exclusion or limitation of incidental or consequential damages, so the above limitation may not apply to you. This warranty gives you specific legal rights, and you may have other rights which vary from state to state.

This warranty does not restrict the rights of the consumer mandated under applicable laws.

THIS WARRANTY SUPERSEDES ALL OTHER WARRANTIES THAT ARE ASSOCIATED OR INCLUDED WITH THIS PRODUCT, EXCEPT THAT ANY SOFTWARE CONTAINED IN OR PACKAGED WITH THIS PRODUCT IS EXCLUDED FROM THIS

WARRANTY AND INSTEAD SHALL BE COVERED BY THE WARRANTY, IF ANY, PROVIDED IN SHURE'S END USER LICENSE AGREEMENT ACCOMPANYING SUCH SOFTWARE.

## Service Centers

### **United States, Canada, Latin America, Caribbean**

Shure Incorporated  
Attn: Service Department  
945 Chaddick Dr.  
Wheeling, IL 60090-6449 U.S.A.

### **Europe, Middle East, and Africa**

Shure Europe GmbH  
Attn: Service  
Jakob-Dieffenbacher-Str. 12,  
75031 Eppingen, Germany

### **Indonesia Service Center Resmi:**

Jakarta Hotline (021) 612 6388  
Medan (061) 6612550  
Surabaya (031) 5032219  
Jogjakarta (0274) 371710  
Denpasar (0361) 766788  
Makasar (0411) 324652