

COLORDash Par-H18X

User Manual



Model ID: COLORDASHPARH18X

CHAUVET
PROFESSIONAL

Edition Notes

The COLORdash Par H18X User Manual includes a description, safety precautions, installation, programming, operation and maintenance instructions for the COLORdash Par H18X as of the release date of this edition.

Trademarks

Chauvet, Chauvet Professional, the Chauvet logo, and COLORdash are registered trademarks or trademarks of Chauvet & Sons, LLC (d/b/a Chauvet and Chauvet Lighting) in the United States and other countries. Other company and product names and logos referred to herein may be trademarks of their respective companies.

Copyright Notice

The works of authorship contained in this manual, including, but not limited to, all designs, text, and images are owned by Chauvet.

© Copyright 2023 Chauvet & Sons, LLC. All rights reserved.

Electronically published by Chauvet in the United States of America.

Manual Use

Chauvet authorizes its customers to download and print this manual for professional information purposes only. Chauvet expressly prohibits the usage, copy, storage, distribution, modification, or printing of this manual or its content for any other purpose without written consent from Chauvet.

Document Printing

For best results, print this document in color, on letter size paper (8.5 x 11 in), double-sided. If using A4 paper (210 x 297 mm), configure the printer to scale the content accordingly.

Intended Audience

Any person installing, operating, and/or maintaining this product should completely read through the guide that shipped with the product, as well as this manual, before installing, operating, or maintaining this product.

Disclaimer

Chauvet believes that the information contained in this manual is accurate in all respects. However, Chauvet assumes no responsibility and specifically disclaims any and all liability to any party for any loss, damage, or disruption caused by any errors or omissions in this document, whether such errors or omissions result from negligence, accident, or any other cause. Chauvet reserves the right to revise the content of this document without any obligation to notify any person or company of such revision, however, Chauvet has no obligation to make, and does not commit to make, any such revisions. Download the latest version from www.chauvetprofessional.com.

Document Revision

Go to www.chauvetprofessional.com for the latest version.

Revision	Date	Description
2	09/2023	Added revision log/DC Power Section and USB Software Update section removed.

TABLE OF CONTENTS

1. Before You Begin	1
What Is Included	1
Claims	1
Text Conventions	1
Symbols	1
Safety Notes.....	2
FCC Statement of Compliance	3
Expected LED Lifespan.....	3
2. Introduction	4
Description	4
Features.....	4
Product Overview.....	4
Product Dimensions.....	5
3. Setup	6
AC Power	6
AC Plug.....	6
Power-Linking	6
DMX Linking.....	6
DMX Personalities.....	6
Remote Device Management.....	6
Master/Slave Connectivity.....	7
Mounting	7
Orientation.....	7
Rigging	7
Procedure.....	7
4. Operation	8
Control Panel Description	8
Programming.....	8
Passcode	8
Menu Map	9
DMX Configuration.....	12
DMX Personalities.....	12
DMX Control.....	12
DMX Values	13
14Ch / 13Ch / 9Ch / 8Ch / 6Ch	13
Standalone Configuration.....	15
Fixed Color.....	15
Color Temperature	15
Manual Color Mixer	15
Auto Show.....	15
Settings Configuration.....	15
Master/Slave	15
Dimmer Speed	15
White Balance	16
LED Frequency	16
Back Light	16
Key Lock	16
Information	16
Factory Reset.....	16
System Update.....	16

5. Maintenance	17
Product Maintenance	17
6. Technical Specifications	18
Contact Us	19
Warranty & Returns.....	19

1. Before You Begin

What Is Included

- COLORdash Par H18X
- Seetronic Powerkon IP65 power cable
- Gel frame holder
- Omega bracket
- Quick Reference Guide

Claims

Carefully unpack the product immediately and check the container to make sure all the parts are in the package and are in good condition.



If the box or the contents (the product and included accessories) appear damaged from shipping, or show signs of mishandling, notify the carrier immediately, not Chauvet. Failure to report damage to the carrier immediately may invalidate a claim. In addition, keep the box and contents for inspection.

For other issues, such as missing components or parts, damage not related to shipping, or concealed damage, file a claim with Chauvet within 7 days of delivery.

Text Conventions

Convention	Meaning
1–512	A range of values
50/60	A set of values of which only one can be chosen
Settings	A menu option not to be modified
<ENTER>	A key to be pressed on the product’s control panel

Symbols

Symbol	Meaning
	Critical installation, configuration, or operation information. Not following these instructions may make the product not work, cause damage to the product, or cause harm to the operator.
	Important installation or configuration information. The product may not function correctly if this information is not used.
	Useful information.



The term “DMX” used throughout this manual refers to the USITT DMX512-A digital data transmission protocol.

Safety Notes

Read all the following safety notes before working with this product. These notes contain important information about the installation, usage, and maintenance of this product.



This product contains no user-serviceable parts. Any reference to servicing in this User Manual will only apply to properly trained, certified technicians. Do not open the housing or attempt any repairs.



All applicable local codes and regulations apply to proper installation of this product.

- The luminaire should be positioned so that prolonged staring into the luminaire at a distance closer than 20 in (0.5 m) is not expected.
- If the external flexible cable or cord of this luminaire is damaged, it shall be replaced by a special cord or cord exclusively available from the manufacturer or its service agent.
- The light source contained in this luminaire shall only be replaced by the manufacturer or its service agent or a similar qualified person.
- The luminaire is intended for professional use only.
- **CAUTION:**
 - This product's housing may be hot when operating. Mount this product in a location with adequate ventilation, at least 20 in (50 cm) from adjacent surfaces.
 - When transferring the product from extreme temperature environments, (e.g., cold truck to warm humid ballroom) condensation may form on the internal electronics of the product. To avoid causing a failure, allow the product to fully acclimate to the surrounding environment before connecting it to power.
 - Flashing light is known to trigger epileptic seizures. User must comply with local laws regarding notification of strobe use.
- **ALWAYS:**
 - Disconnect from power before cleaning the product or replacing the fuse.
 - Replace the fuse with the same type and rating.
 - Use a safety cable when mounting this product overhead.
 - Connect this product to a grounded and protected circuit.
- **DO NOT:**
 - Open this product. It contains no user-serviceable parts.
 - Look at the light source when the product is on.
 - Leave any flammable material within 50 cm of this product while operating or connected to power.
 - Connect this product to a dimmer or rheostat.
 - Operate this product if the housing, lenses, or cables appear damaged.
 - Operate this product outdoors or in any location where dust, excessive heat, water, or humidity may affect it (adhere to standards for the published IP rating).
 - ONLY use the hanging/mounting bracket to carry this product.
 - The maximum ambient temperature is 113 °F (45 °C). Do not operate this product at higher temperatures.
 - The minimum startup temperature is -4°F (-20°C). Do not start the product at lower temperatures.
 - The minimum ambient temperature is -22°F (-30°C). Do not operate the product at lower temperatures.
 - To eliminate unnecessary wear and improve its lifespan, during periods of non-use completely disconnect the product from power via breaker or by unplugging it.
 - In the event of a serious operating problem, stop using immediately.



If a Chauvet product requires service, contact Chauvet Technical Support.

Before You Begin

FCC Statement of Compliance

This device complies with Part 15 Part B of the FCC rules. Operation is subject to the following two conditions:

1. This device may not cause harmful interference, and
2. This device must accept any interference received, including interference that may cause undesired operation.

This equipment has been tested and found to comply with the limits for a Class B digital device, pursuant to Part 15 of the FCC Rules. These limits are designed to provide reasonable protection against harmful interference in a residential installation. This equipment generates uses and can radiate radio frequency energy and, if not installed and used in accordance with the instructions, may cause harmful interference to radio communications. However, there is no guarantee that interference will not occur in a particular installation. If this equipment does cause harmful interference to radio or television reception, which can be determined by turning the equipment off and on, the user is encouraged to try to correct the interference by one or more of the following measures:

- Reorient or relocate the receiving antenna.
- Increase the separation between the equipment and receiver.
- Connect the equipment into an outlet on a circuit different from that to which the receiver is connected.
- Consult the dealer or an experienced radio/TV technician for help.

Any changes or modifications not expressly approved by the party responsible for compliance could void the user's authority to operate the equipment.

Expected LED Lifespan

Over time, use and heat will gradually reduce LED brightness. Clustered LEDs produce more heat than single LEDs, contributing to shorter lifespans if always used at full intensity. The average LED lifespan is 40,000 to 50,000 hours. To extend LED lifespan, maintain proper ventilation around the product, and limit the overall intensity.

2. Introduction

Description

The COLORdash Par H18X efficiently delivers a broad palette of subtle to saturated color with beautiful precision and over 5,700 lumens of output. Flawlessly smooth 16-bit fades with four selectable dimming curves. Flicker-free output with multiple PWM frequencies. Punch up a hot pink, mix a delicate pastel, pick a perfectly calibrated Kelvin color temperature, or trigger intense strobe effects. With RDM to remotely choose its DMX personality and an OLED display to easily read its onboard menu, the COLORdash PAR H18X is a die-cast workhorse that withstands the rigors of real world use while offering convenient operation and excellent performance, in the rig or on the floor, live or on camera.

Features

- Full-spectrum LED 1x1 format soft light panel style fixture for broadcast, film, and special events
- IP65 rating for all weather use indoors or out
- Linear color temperature presets from 2800 K to 8000 K with high CRI and CQS
- Virtual color wheel with color matched to popular gel colors
- +/- Green adjustment and emulated red-shift via DMX or on-board control
- RDM (Remote Device Management) and CRMX Wireless Control for added flexibility
- Adjustable PWM (Pulse Width Modulation) to avoid flickering on camera
- Virtually silent operation for use in studio applications
- Ultra-smooth 16-bit dimming curves and speeds to complement any lighting scheme
- Easily switch mounting options from Jr Pin to Omega Bracket
- Drop-in slot for diffusers and intensifier filter (sold separately)
- Rugged design for years of rough use in the most extreme conditions
- Easy to use on-board control with full access to all the features of the fixture without the need for a dedicated controller
- USB port for fixture software updates
- 28 VDC power input via 3-pin XLR to power the fixture from an external battery pack

Product Overview

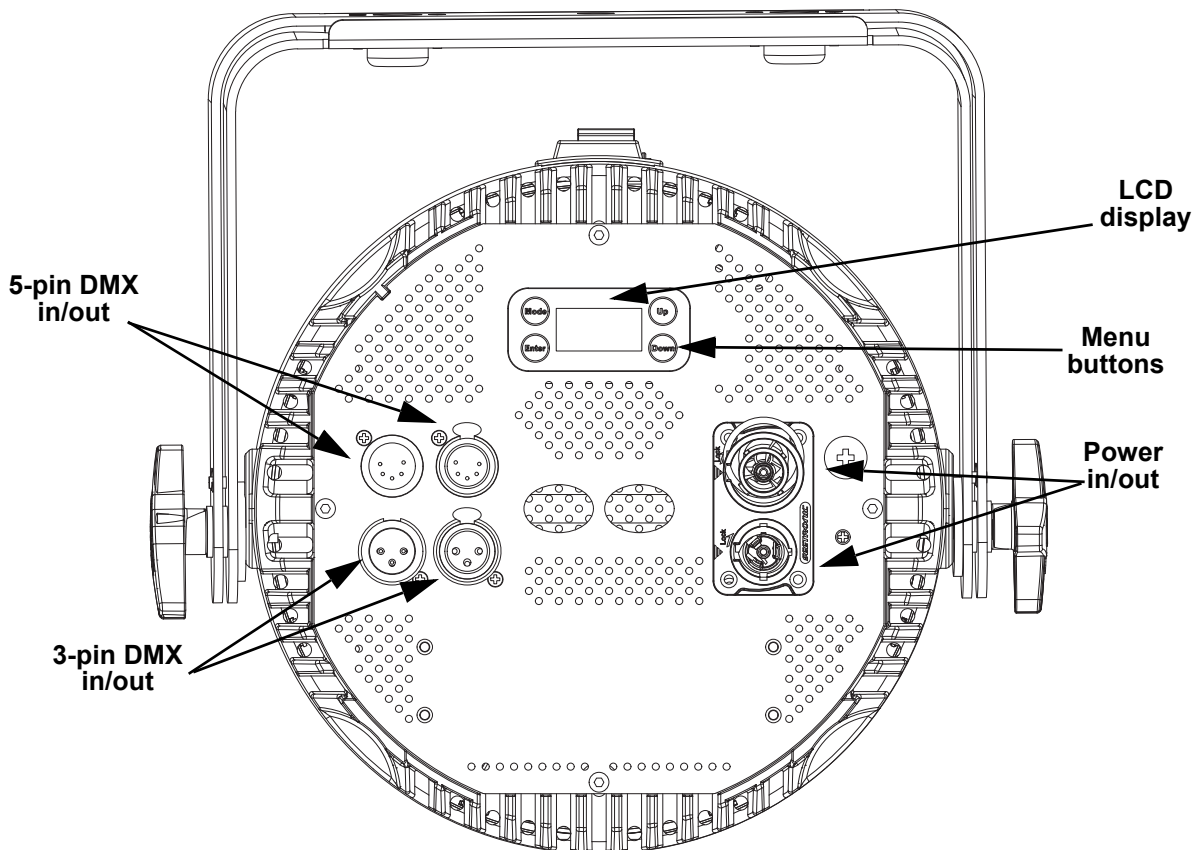

Product Dimensions

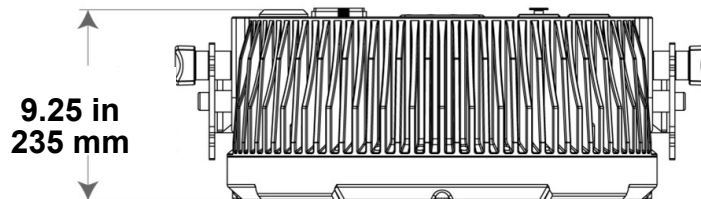
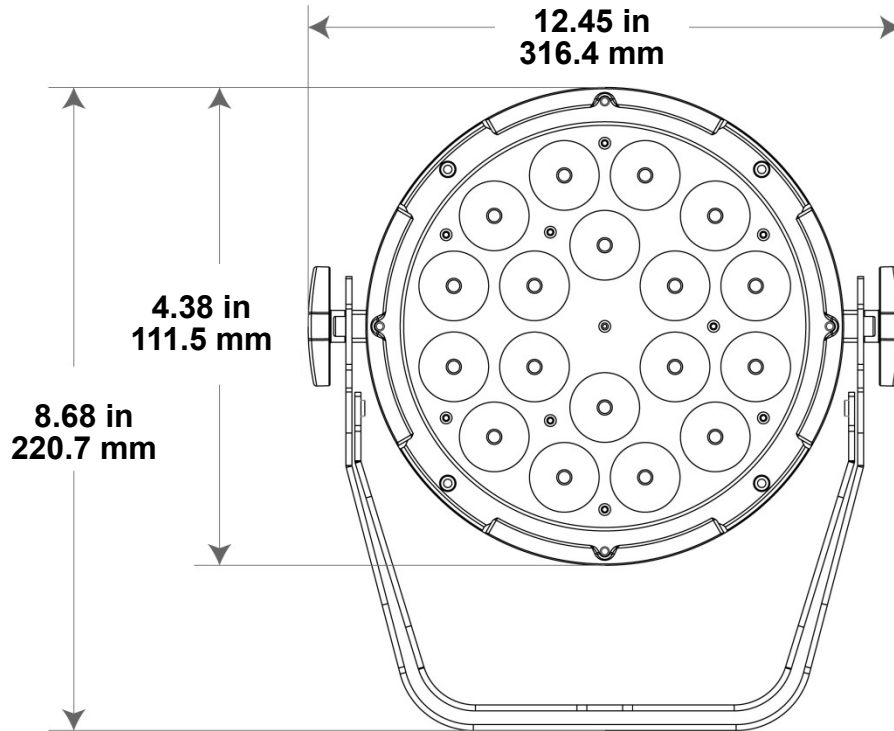

3. Setup

AC Power

The COLORdash Par H18X has an auto-ranging power supply and it can work with an input voltage range of 100 to 240 VAC, 50/60 Hz.

To determine the product's power requirements (circuit breaker, power outlet, and wiring), use the current value listed on the label affixed to the product's back panel, or refer to the product's specifications chart.

The listed current rating indicates the product's average current draw under normal conditions.



- **Always connect the product to a protected circuit (a circuit breaker or fuse). Make sure the product has an appropriate electrical ground to avoid the risk of electrocution or fire.**
- **To eliminate unnecessary wear and improve its lifespan, during periods of non-use completely disconnect the product from power via breaker or by unplugging it.**



Never connect the product to a rheostat (variable resistor) or dimmer circuit, even if the rheostat or dimmer channel serves only as a 0 to 100% switch.

AC Plug

The COLORdash Par H18X comes with a power input cord terminated with a Seetronic Powerkon IP65 connector on one end and an Edison plug on the other end (U.S. market). If the power input cord that came with the product has no plug, or the user needs to change the plug, use the table below to wire the new plug.

Connection	Wire (U.S.)	Wire (Europe)	Screw Color
AC Live	Black	Brown	Yellow or Brass
AC Neutral	White	Blue	Silver
AC Ground	Green/Yellow	Green/Yellow	Green

Power-Linking

This product comes with a power input cord. Power-linking cables are available from Chauvet for purchase. It is possible to power link COLORdash Par H18X products. See the table below for the current draw at each voltage and frequency:

	100 V, 60 Hz	120 V, 60 Hz	208 V, 60 Hz	230 V, 50 Hz	240 V, 50 Hz
Current Draw	1.580 A	1.305 A	0.773 A	0.704 A	0.679 A

Never exceed 12 A on a single circuit. Power-linking cables can be purchased separately

DMX Linking

The COLORdash Par H18X can work with a DMX controller using a 3- or 5-pin DMX connection. If using other DMX-compatible products with this product, it's possible to control each individually with a single DMX controller.

DMX Personalities

The COLORdash Par H18X uses a 3- or 5-pin DMX data connection for the **6CH**, **8CH**, **9CH**, **13CH**, and **14CH** DMX personalities.

- Refer to the [Operation](#) chapter to learn how to configure the COLORdash Par H18X to work in these personalities.
- The [Control Channel Assignments and Values](#) section provides detailed information regarding the DMX personalities.



For information about DMX standards, Master/Slave connectivity, or the DMX cables needed to link this product to a DMX controller, download the DMX Primer from the Chauvet website: www.chauvetprofessional.com.

Remote Device Management

Remote Device Management, or RDM, is a standard for allowing DMX-enabled devices to communicate bi-directionally along existing DMX cabling. Check the DMX controller's User Manual or with the manufacturer as not all DMX controllers have this capability. The COLORdash Par H18X supports RDM protocol that allows feedback to make changes to menu map options.

Master/Slave Connectivity

The Master/Slave mode allows a COLORdash Par H18X (the master) to control one or more COLORdash Par H18X products (the slaves) without a DMX controller. One COLORdash Par H18X becomes the master when running in auto show or VCW modes.

Each slave's control panel must be configured to operate in Slave mode. During Master/Slave operation, the slaves will operate in unison with the master.



DO NOT connect a DMX controller to products operating in Master/Slave mode. The DMX controller signals may interfere with the signals from the master.



- The [Operation](#) section of this manual provides detailed instructions on how to configure the master and slaves.
- For more information about DMX standards or the DMX cables needed to link this product to a DMX controller, download the DMX Primer from the Chauvet website: www.chauvetprofessional.com.

Mounting

Before mounting the product, read and follow the safety recommendations indicated in the Safety Notes.

Orientation

Always mount this product in a safe position, making sure there is adequate room for ventilation, configuration, and maintenance.

Rigging

Chauvet recommends using the following general guidelines when mounting this product.

- Before deciding on a location for the product, make sure there is easy access to the product for maintenance and programming purposes.
- Make sure that the structure and attachment points can support the weight before hanging the product (see the [Technical Specifications](#) for weight information).
- When mounting the product overhead, always use a safety cable. Mount the product securely to a rigging point, whether an elevated platform or a truss.
- When rigging the product onto a truss, use a mounting clamp of appropriate weight capacity.

Procedure

The COLORdash Par H18X comes with an omega bracket. Mounting clamps are sold separately. Make sure the clamp is capable of supporting the weight of this product. For the Chauvet Professional line of mounting clamps, go to <http://www.trusst.com/products>.

Mounting Diagram

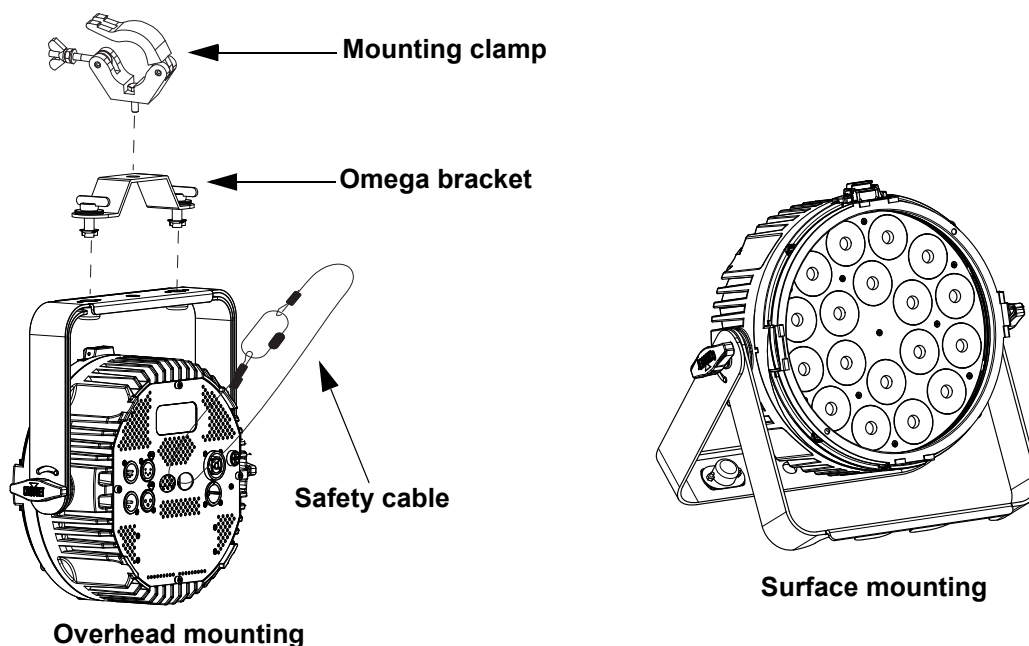

4. Operation

Control Panel Description

Button	Function
<MENU>	Exits from the current menu or function
<ENTER>	Enables the currently displayed menu or sets the currently selected value into the selected function
<UP>	Navigates upwards through the menu list or increases the numeric value when in a function
<DOWN>	Navigates downwards through the menu list or decreases the numeric value when in a function

Programming

Refer to the menu map to understand the menu options. The menu map shows the main menu and a variable number of programming levels for each option.

- To go to the desired main level, press <MENU> repeatedly until the option shows on the display. Press <ENTER> to select.
- To select an option or value within the current programming level, press <UP> or <DOWN> until the option shows on the display. Press <ENTER> to select.
- Press <MENU> repeatedly to exit to the previous main level.

Passcode

When prompted, enter the following passcode: <UP>, <DOWN>, <UP>, <DOWN>, <ENTER>.

This passcode cannot be changed.

Operation

Menu Map

Refer to the COLORdash Par H18X product page on www.chauvetprofessional.com for the latest menu map.

Main Level	Programming Levels	Description	
DMX Address	001–507	Sets the starting address	
DMX Channel	6CH	6-channel: RGBAWUV	
	8CH	8-channel: dimmer, RGBAWUV, strobe	
	9CH	9-channel: 16-bit dimmer, RGBAWUV, strobe	
	13CH	13-channel: dimmer, RGBAWUV, strobe, color macro, color temperature, auto programs and speed, dimmer mode	
	14CH	14-channel: 16-bit dimmer, RGBAWUV, strobe, color macro, color temperature, auto programs and speed, dimmer mode	
Static	Fixed Color	R	Red
		G	Green
		B	Blue
		A	Amber
		W	White
		UV	Ultraviolet (UV)
		RG	Red/Green
		RB	Red/Blue
		RA	Red/Amber
		RW	Red/White
		RUV	Red/UV
		GB	Green/Blue
		GA	Green/Amber
		GW	Green/White
		GUV	Green/UV
		BA	Blue/Amber
		BW	Blue/White
		BUV	Blue/UV
		AW	Amber/White
		AUV	Amber/UV
		WUV	White/UV
		RGB	Red/Green/Blue
		RGA	Red/Green/Amber
		RGW	Red/Green/White
		RGUV	Red/Green/UV
		RBA	Red/Blue/Amber
RBW	Red/Blue/White		
RBUV	Red/Blue/UV		

Main Level	Programming Levels	Description	
Static (cont.)	RAW	Red/Amber/White	
	RAUV	Red/Amber/UV	
	RWUV	Red/White/UV	
	GBA	Green/Blue/Amber	
	GBW	Green/Blue/White	
	GBUV	Green/Blue/UV	
	GAW	Green/Amber/White	
	GAUV	Green/Amber/UV	
	GWUV	Green/White/UV	
	BAW	Blue/Amber/White	
	BAUV	Blue/Amber/UV	
	BWUV	Blue/White/UV	
	AWUV	Amber/White/UV	
	RGBA	Red/Green/Blue/Amber	
	RGBW	Red/Green/Blue/White	
	RGBUV	Red/Green/Blue/UV	
	RGAW	Red/Green/Amber/White	
	RGAUV	Red/Green/Amber/UV	
	RGWUV	Red/Green/White/UV	
	RBAW	Red/Blue/Amber/White	
	RBAUV	Red/Blue/Amber/UV	
	RBWUV	Red/Blue/White/UV	
	RAWUV	Red/Amber/White/UV	
	GBAW	Green/Blue/Amber/White	
	GBAUV	Green/Blue/Amber/UV	
	GBWUV	Green/Blue/White/UV	
	GAWUV	Green/Amber/White/UV	
	BAWUV	Blue/Amber/White/UV	
	RGBAW	Red/Green/Blue/Amber/White	
	RGBAUV	Red/Green/Blue/Amber/UV	
	RGBWUV	Red/Green/Blue/White/UV	
	RGAWUV	Red/Green/Amber/White/UV	
	RBAWUV	Red/Blue/Amber/White/UV	
	GBAWUV	Green/Blue/Amber/White/UV	
	RGBAWUV	Red/Green/Blue/Amber/White/UV	
	Color Temperature	Warm White 1	Preset white color temperatures
		Warm White 2	
		Warm White 3	
		Neutral White 1	
		Neutral White 2	
		Neutral White 3	
		Daylight 1	
Daylight 2			
Daylight3			
Daylight 4			

Operation



Main Level	Programming Levels		Description
Static (cont.)	Manual Color Mixer	Red	000–255 Combine red, green, blue, amber, white, and ultraviolet to make a custom color (0–100%)
		Green	
		Blue	
		Amber	
		White	
		UV	
Auto show	Auto 1–5	001–100	Automatic programs and speed
Master/Slave	Master		DMX mode (Master)
	Slave		Slave mode
Dimmer Mode	Off		Linear dimmer
	Dimmer1–3		Dimmer speed, fast (1) to slow (3)
White Balance	Manual	Off	Uses factory default white setting
		Red	Sets maximum red value
		Green	Sets maximum green value
		Blue	Sets maximum blue value
		Amber	Sets maximum amber value
		White	Sets maximum white value
		UV	Sets maximum UV value
LED Frequency	600Hz		Sets the Pulse Width Modulation frequency
	1200Hz		
	2000Hz		
	4000Hz		
	6000Hz		
	25kHz		
Back Light	10S		Display turns off after 10 seconds
	30S		Display turns off after 30 seconds
	2Min		Display turns off after 2 minutes
	Always On		Display stays on
Key Lock	On		Locks the display. Passcode: <UP>, <DOWN>, <UP>, <DOWN>, <ENTER>
	Off		
Information	Fixture Hours	<_ _ _ _ H>	Shows hours product has been on
	Version	<V_ _ _ _ _>	Shows the current firmware version
	UID	<_ _ _ _ _ _ _ _>	Shows the product UID
Reset Factory	NO		Reset to factory default settings
	YES		
System Update	Put the update file into the USB stick and connect it to the device through an adapter cable.		Update firmware via USB to DMX adapter cable
	NO		
	YES		

DMX Configuration

Use DMX configurations to operate the product with a DMX controller.

DMX Personalities

This setting allows users to choose a particular DMX personality.

1. Go to the **DMX Channel** main level.
2. Select the desired personality (**6Ch**, **8Ch**, **9Ch**, **13Ch**, or **14Ch**).
 - See the [DMX Control](#) section for the highest starting address available for each personality.
 - Make sure that the starting addresses on the various products do not overlap due to the new personality setting.



DMX Control

In this mode, each product will respond to a unique starting address from the DMX controller. All products with the same starting address will respond in unison.

1. Select a DMX personality as shown in [DMX Personalities](#).
2. Set the running mode:
 - a. Go to the **Master/Slave** main level
 - b. Select the **Master** programming level
3. Set the starting address:
 - a. Go to **Start Address** main level.
 - b. Select the starting address (**001–507**).

The highest recommended starting address for each DMX personality is as follows:

DMX Personality	Starting Address
14Ch	499
13Ch	500
9Ch	504
8Ch	505
6Ch	507

Operation

DMX Values

14Ch / 13Ch / 9Ch / 8Ch / 6Ch

6CH	8CH	9CH	13CH	14CH	Function	Value	Percent/Setting
-	1	1	1	1	Dimmer	000 ⇔ 255	0–100%
-	-	2	-	2	Fine dimmer	000 ⇔ 255	0–100%
1	2	3	2	3	Red	000 ⇔ 255	0–100%
2	3	4	3	4	Green	000 ⇔ 255	0–100%
3	4	5	4	5	Blue	000 ⇔ 255	0–100%
4	5	6	5	6	Amber	000 ⇔ 255	0–100%
5	6	7	6	7	White	000 ⇔ 255	0–100%
6	7	8	7	8	UV	000 ⇔ 255	0–100%
-	8	9	8	9	Strobe	000 ⇔ 010	No function
						011 ⇔ 255	Strobe, slow to fast
-	-	-	9	10	Color macro	000 ⇔ 010	No function
						011	Red full
						012 ⇔ 029	Red full, green increases
						030	Red and green full
						031 ⇔ 049	Green full, red decreases
						050	Green full
						051 ⇔ 069	Green full, blue increases
						070	Green and blue full
						071 ⇔ 089	Blue full, green decreases
						090	Blue full
						091 ⇔ 109	Blue full, red increases
						110	Red and blue full
						111 ⇔ 129	Red full, blue decreases
						130	Red full
						131 ⇔ 149	Red full, green and blue increase
					150	Red, green, and blue full	
					151 ⇔ 169	Blue full, red and green decrease	
					170	Blue full	
					171 ⇔ 200	Red, green, and blue full	
					201 ⇔ 255	Color temperature, warm to cool	
-	-	-	10	11	Color temperature	000 ⇔ 005	No function
						006 ⇔ 025	Warm white 1
						026 ⇔ 050	Warm white 2
						051 ⇔ 075	Warm white 3
						076 ⇔ 100	Neutral white 1
						101 ⇔ 125	Neutral white 2
						126 ⇔ 150	Neutral white 3
						151 ⇔ 175	Daylight 1
						176 ⇔ 200	Daylight 2
						201 ⇔ 225	Daylight 3
					226 ⇔ 250	Daylight 4	
					251 ⇔ 255	No function	

6CH	8CH	9CH	13CH	14CH	Function	Value	Percent/Setting
-	-	-	11	12	Automatic programs	000 ⇔ 010	No function
						011 ⇔ 060	Automatic program 1
						061 ⇔ 110	Automatic program 2
						111 ⇔ 160	Automatic program 3
						161 ⇔ 210	Automatic program 4
					211 ⇔ 255	Automatic program 5	
-	-	-	12	13	Program speed	000 ⇔ 255	Automatic program speed, slow to fast
-	-	-	13	14	Dimmer mode	000 ⇔ 051	Preset dimmer speed from display menu
						052 ⇔ 101	Linear dimmer
						102 ⇔ 152	Dimmer mode 1 (fastest)
						153 ⇔ 203	Dimmer mode 2
					204 ⇔ 255	Dimmer mode 3 (slowest)	

Operation

Standalone Configuration

Fixed Color

To select a preset fixed color combination:

1. Go to the **Static** main level.
2. Select the desired combination of **R** (red), **G** (green), **B** (blue), **A** (amber), **W** (white), and/or **UV** (ultraviolet), from **R, G, B, A, W, UV, RG, RB, RA, RW, RUV, GB, GA, GW, GUV, BA, BW, BUV, AW, AUV, WUV, RGB, RGA, RGW, RGUV, RBA, RBW, RBUV, RAW, RAUV, RWUV, GBA, GBW, GBUV, GAW, GAUV, GWUV, BAW, BAUV, BWUV, AWUV, RGBA, RGBW, RGBUV, RGAW, RGAUV, RGWUV, RBAW, RBAUV, RBWUV, RAWUV, GBAW, GBAUV, GBWUV, GAWUV, BAWUV, RGBAW, RGBAUW, RGBWUV, RGAWUV, RBAWUV, GBAWUV, or RGBAWUV.**

Color Temperature

To select a preset color temperature:

1. Go to the **Static** main level.
2. Select the **Color Temperature** option.
3. Select the color temperature, from **Warm White 1, Warm White 2, Warm White 3, Neutral White 1, Neutral White 2, Neutral White 3, Daylight 1, Daylight 2, Daylight 3, or Daylight 4.**

Manual Color Mixer

To manually mix a custom static color:

1. Go to the **Static** main level.
2. Select the **Manual Color Mixer** option.
3. Select the color value to alter, from **Red, Green, Blue, Amber, White, or UV.**
4. Set the value of the selected color, from **000–255.**

Auto Show

To select an automatic program:

1. Go to the **Auto show** main level.
2. Select the program, from **Auto 1–5.**
3. Set the program speed, from **001–100.**

Settings Configuration

Master/Slave

The Master/Slave mode allows a group of COLORdash Par H18X products (the slaves) to simultaneously duplicate the output of another COLORdash Par H18X (the master) without a DMX controller.

To set each of the slaves:

1. Go to the **Master/Slave** main level
2. Select **Slave.**

To set the master:

1. Go to the **Master/Slave** main level
2. Select **Master.**
3. Select a standalone setting.



- The master is the one that runs a program whether in Auto or Static mode.
- Do not connect a DMX controller to the products configured for Master/Slave operation. The DMX controller may interfere with signals from the master.
- The master should be the first product in the daisy chain.

Dimmer Speed

This setting determines how fast the output of the COLORdash Par H18X changes when the output value is modified. It provides four different options to simulate the dimming curve of an incandescent lighting product. To select a specific dimmer profile, do the following:

1. Go to the **Dimmer Speed** main level.
2. Select a dimmer curve (**Off, Dimmer 1, Dimmer 2, or Dimmer 3**).



- Off:** The output is proportional (linear) to the dimmer channel value.
- Dimmer 1–3:** The output follows the dimmer value based on the corresponding dimmer curve, **Dimmer 1** being the fastest.

White Balance

This setting determines the maximum output values for each color, which affects the appearance of the total color output.

1. Go to the **White Balance** main level.
2. Select from **Off** (uses factory default white setting) or **Manual** (uses a custom white balance).
3. Select the color value to alter, from **Red, Green, Blue, Amber, White, or UV**.
4. Set the maximum value of the selected color, from **125–255**.

LED Frequency

To adjust the frequency of the pulse width modulation:

1. Go to the **LED Frequency** main level.
2. Select the frequency, from **600Hz, 1200Hz, 2000Hz, 4000Hz, 6000Hz, or 25kHz**.

Back Light

To set how long before an inactive display will turn off:

1. Go to the **Back Light** main level.
2. Select the length of the backlight timer, from **10S** (10 seconds), **30S** (30 seconds), **2Min** (2 minutes), or **Always On**.

Key Lock

To lock the display with a passcode:

1. Go to the **Key Lock** main level.
2. Select **On** (lock the display) or **Off** (unlock the display).

Information

To view essential product information:

1. Go to the **Information** main level.
2. Select **Fixture Hours, Version, or UID**.

Factory Reset

To reset the product to factory settings:

1. Go to the **Reset Factory** main level.
2. Select **NO** (to cancel) or **YES** (to reset the product configuration).

System Update

To update the firmware with a USB to DMX adapter cable:

1. Go to the **System Update** main level.
2. Follow the instructions (**Put the update file into the USB stick and connect it to the device through an adapter cable**).
3. Select **NO** (to cancel) or **YES** (to update the firmware).

5. Maintenance

Product Maintenance

Dust build-up reduces light output performance and can cause overheating. This can lead to reduction of the light source's life and/or mechanical wear. To maintain optimum performance and minimize wear, clean all lighting products at least twice a month. However, be aware that usage and environmental conditions could be contributing factors to increase the cleaning frequency.

To clean the product, follow the instructions below:

1. Unplug the product from power.
2. Wait until the product is at room temperature.
3. Use a vacuum (or dry compressed air) and a soft brush to remove dust collected on the external surface/vents.
4. Clean all transparent surfaces with a mild soap solution, ammonia-free glass cleaner, or isopropyl alcohol.
5. Apply the solution directly to a soft, lint free cotton cloth or a lens cleaning tissue.
6. Softly drag any dirt or grime to the outside of the transparent surface.
7. Gently polish the transparent surfaces until they are free of haze and lint.



Always dry the transparent surfaces carefully after cleaning them.

6. Technical Specifications

Dimensions and Weight

Length	Width	Height	Weight
12.45 in (316.4 mm)	4.38 in (111.5 mm)	8.68 in (220.7 mm)	10.4 lb (4.7 kg)

Note: Dimensions in inches are rounded.

Power

Power Supply Type	Range	Voltage Selection
Switching (internal)	100 to 240 VAC, 50/60 Hz	Auto-ranging

Parameter	100 V, 60 Hz	120 V, 60 Hz	208 V, 60 Hz	230 V, 50 Hz	240 V, 50 Hz
Consumption	161 W	155 W	153 W	152 W	152 W
Operating Current	1.580 A	1.305 A	0.773 A	0.704 A	0.679 A

Power I/O	U.S./Worldwide	UK/Europe
Power Input Connectors	Seetronic Powerkon IP65	Seetronic Powerkon IP65
Power Output Connector	Seetronic Powerkon IP65	Seetronic Powerkon IP65
Power Cord plug	Edison (U.S.)	Local Plug

Light Source

Type	Color	Quantity	Power	Current	Lifespan
LED	HEX-color RGBWAUV	18	150 W	550 mA	50,000 hours

Photometrics

Color Temperature (Range)	Color Temperature (At Full)	Beam Angle	Field Angle	Illuminance @ 5 m
2800 to 10000 K	9507 K	23.6°	38.6°	1,207 lux

Thermal

Startup Temperature Range	Operating Temperature Range	Cooling System
-4 °F–113 °F (-20 °C–45 °C)	-22 °F–113 °F (-30 °C–45 °C)	Fan-assisted Convection

DMX

I/O Connector	Channel Range
3- and 5-pin XLR	6, 8, 9, 13, 14

Art-Net™/sACN

I/O Connector	Channel Range
Seetronic Etherkon-Compatible	6Ch, 8Ch, 9Ch, 13Ch, 14Ch

Ordering

Product Name	Item Name	Item Code	UPC Number
COLORdash Par H18X	COLORDASHPARH18X	10031873	781462222215



UL 1573
CSA C22.2 No. 166
E113093



RoHS

Contact Us

General Information	Technical Support
Chauvet World Headquarters	
Address: 3360 Davie Rd. Davie, FL 33314 Voice: (954) 577-4455 Fax: (954) 929-5560 Toll Free: (800) 762-1084	Voice: (844) 393-7575 Fax: (954) 756-8015 Email: chauvetcs@chauvetlighting.com Website: www.chauvetdj.com
Chauvet U.K.	
Address: Pod 1 EVO Park Little Oak Drive, Sherwood Park Nottinghamshire, NG15 0EB UK Voice: +44 (0) 1773 511115 Fax: +44 (0) 1773 511110	Email: UKtech@chauvetlighting.eu Website: www.chauvetdj.eu
Chauvet Benelux	
Address: Stokstraat 18 9770 Kruishoutem Belgium Voice: +32 9 388 93 97	Email: BNLtech@chauvetlighting.eu Website: www.chauvetdj.eu
Chauvet France	
Address: 3, Rue Ampère 91380 Chilly-Mazarin France Voice: +33 1 78 85 33 59	Email: FRtech@chauvetlighting.fr Website: www.chauvetdj.eu
Chauvet Germany	
Address: Bruno-Bürgel-Str. 11 28759 Bremen Germany Voice: +49 421 62 60 20	Email: DEtech@chauvetlighting.de Website: www.chauvetdj.eu
Chauvet Mexico	
Address: Av. de las Partidas 34 - 3B (Entrance by Calle 2) Zona Industrial Lerma Lerma, Edo. de México, CP 52000 Voice: +52 (728) 690-2010	Email: servicio@chauvet.com.mx Website: www.chauvetdj.mx

Warranty & Returns

For warranty terms and conditions and return information, please visit our website.

For customers in the United States and Mexico: www.chauvetlighting.com/warranty-registration.

For customers in the United Kingdom, Republic of Ireland, Belgium, the Netherlands, Luxembourg, France, and Germany: www.chauvetlighting.eu/warranty-registration.