

COL600

24-Inch (600 mm) Slim Column Loudspeaker



HIGHLIGHTS

A combination of stylish design and outstanding performance features makes the COL600 slim column loudspeaker ideal for a wide variety of applications, such as conference/meeting rooms, lecture halls, retail stores, concourses, transit spaces, fill applications, audio for video, and other applications where slim, compact design and high performance is desired.

The COL600 is an elegant column loudspeaker that provides wide horizontal and narrow vertical coverage, with a built-in 10° down-tilt to the aim, providing optimum coverage of most listening areas while allowing the speaker to be installed flat to the wall.

The slim, compact design—winner of international design awards for industrial design excellence—complements virtually any architectural décor. Two 5-inch x 2.25 inch racetrack woofers provide maximum radiating area in a column form factor. The tweeter is located at the top of array for less obstructed coverage of the listening space and is aimed at a down angle, allowing down-tilted coverage aim, even with the cabinet flat to the wall. The shallow cabinet depth of 3.7 inches (93 mm) qualifies for ADA (Americans with Disabilities Act) projects when installed with the back of the cabinet flush to the wall.

A 20-watt multi-tap transformer allows for use on either 70V or 100V distributed speaker lines, while the speaker is switchable for direct 8-ohm operation with power handling of 80W continuous (320W peak, 2 hrs.).

The 70 Hz to 20 kHz frequency range delivers clean, clear sound for music or speech.

Versatile installation is accommodated by two included L-brackets, which can be installed on either the top and bottom panels (for +95° horizontal pan aiming) or on the left and right side panels. Both locations allow for close-to-the-wall installation. In addition, a low-profile swivel (pan) / tilt wall bracket is also included, for adding up to 10° down-tilt to the cabinet aiming (in addition to the built-in 10° down-tilt aim when the speaker is installed flat to the wall). (Note that down-tilt may be limited by wall.)

The COL600 has an IP54 rating (per IEC60529) for protection against ingress of dust or water. The drivers are water-treated, the grille has a water-backing, and a cover is included to protect the input terminals. Available in black (JBL-COL600-BK) or white (JBL-COL600-WH).

FEATURES

- Two 5 x 2.25 inch racetrack woofers & one 1 inch tweeter
- 24 inch tall with shallow 3.7 inch cabinet depth
- Wide 160° horizontal and focused 110° vertical coverage
- 10° downward tilt to aim for covering most listening areas without requiring physical down-tilting of the cabinet
- 80W continuous pink noise power handling (320W peak)
- 70 Hz – 20 kHz frequency range
- Built-in 20W 70V/100V multi-tap transformer, plus 8 ohm direct input.
- 111 dB peak SPL (105 dB continuous), 2 hrs
- Tweeter near top of column for unobstructed coverage of listening space
- Versatile mounting brackets included – both close-to-wall L-brackets and low-profile swivel(pan)/tilt wall bracket

SPECIFICATIONS

| SYSTEM | |
|------------------------------------------|----------------------------------------------------------------------------------------------------------------------------------------------------------------------------------------------------------|
| Frequency Range ¹ (-10 dB): | 70 Hz – 20 kHz |
| Frequency Response ¹ (±3 dB): | 105 Hz – 20 kHz |
| Power Rating ² : | 160W Continuous Program (2 hrs) 80W (320W peak) Continuous Pink Noise (2 hrs) 60W (240W peak) Continuous Pink Noise (100 hrs) |
| Sensitivity (2.83V @ 1m) ³ : | 86 dB |
| Coverage Pattern: | Vertical 110° [1kHz-4 kHz average]; 10° down-tilt to aiming access for +45°/-65° coverage in relation to physical cabinet aim Horizontal 160° [1kHz – 4 kHz average] |
| Directivity (Q): | 7.8 |
| Directivity Index (DI): | 8.9 dB |
| Rated Maximum SPL ⁴ : | 105 dB Continuous (111 dB peak) @ 1m |
| Nominal Impedance: | 8Ω (in Thru/direct mode) |
| Minimum Impedance: | 7.0 Ω @ 275 Hz |
| Transformer Taps: | 20W, 10W, 5W @ both 70V & 100V (plus 2.5W @ 70V), and 8Ω thru, selectable via switch |
| Transformer Insertion Loss: | Less than 1 dB for all taps |
| Maximum Input Voltage: | 21 V RMS (2 hrs), 42 V peak |
| Recommended Protective High-Pass: | 70 Hz for 8 Ω operation; 60 Hz for all transformer tap settings (20W, 10W, 5W and 2.5W) |
| TRANSDUCER | |
| Drivers: | Two 125 x 55 mm (5 x 2.25 in.) racetrack LF drivers One 25 mm (1 in.) tweeter (tweeter located at top of array for better coverage of listening space) |
| ENCLOSURE | |
| Enclosure Material: | PC + ABS, UL94-V0 flammability rating |
| Grille: | Plated SPCC with polyester powder coat finish |
| Environmental: | IP-54 rated per IEC60529, dust and water protected when installed with included cover for input terminal compartment and no physical up-tilt cabinet aiming. UV resistant. [Cycle 1 per ISO 4892.3-2006] |
| Agency ratings: | Transformer UL recognized. RoHS, REACH compliance. LVD for CE. |
| Terminals: | 4-pin Euroblock connection for bare wire, accepts 20 to 14 AWG gauge wire (0.5 to 2.5 sq mm). Rain cover allows for one or two 2-wire cables, with max cable jacket diameter of 8 mm (0.3 in) |

COL600

24-Inch (600 mm) Slim Column Loudspeaker



Insert Points

Back Panel: 2 threaded insert points for WALL BRACKET, attaches via included M6 x 20 mm bolts, flat washers, & lock washers; plus 1 threaded insert point for secondary safety cable, M6 threaded x 20 mm deep.

Top & Bottom Caps: 1 threaded insert point on each cap (top & bottom, 2 insert points total) for L-BRACKET; attaches via included M6 x 28 mm bolts, flat washers, and lock washers. (Remove silicon caps over insert points AND remove pre-installed bolts holding end cap in place.) [Note: For installer-specified attachment to these threaded insert points (without L-bracket), insert is M6 x 28 mm deep.]

Side Panels: 1 threaded insert point on each side (left and right, for 2 insert points total) for L-BRACKET; attaches via included M6 x 28 mm bolts, flat washers, and lock washers. (Remove silicon caps over insert points) [Note: For installer-specified attachment to these threaded insert points (without L-bracket), insert is M6 x 22 mm deep.]

Mounting:

Multiple mounting methods (see Installation Guide for more details):

a) Included Swivel (Pan) / Tilt WALL BRACKET provides continuously variable $\pm 95^\circ$ degree Horizontal left-right swivel (pan) aiming (at 0° down-tilt); continuously adjustable $+0^\circ/-10^\circ$ Vertical tilt (when no interference to wall). WALL and SPEAKER sections of WALL BRACKET ASSEMBLY attached together via included M6 x 12 mm bolts, flat washers, and lock washers.

b) Two included L-brackets that can be positioned on either top & bottom insert points or side-side insert points.

c) Top, bottom, and 2 side threaded insert points can be interfaced by installer for installer-supplied mounting methods. Installer responsible for safety of mounting method.

Dimensions (H x W x D):

598 x 102 x 93 mm (23.6 x 4.1 x 3.7 inches)

Net Weight:

3.5 kg (7.8 lbs) each

Shipping Weight:

4.5 kg (10.0 lbs) each (packed 1 speaker per carton)

Included Accessories:

Low-profile SWIVEL (PAN) / TILT WALL BRACKET; Trim Cover for WALL BRACKETS; 2 x L-BRACKETS that can be positioned on top/bottom or side/side insert points.

SKU Numbers and Colors:

JBL-COL600-BK (black, RAL9004), JBL-COL600-WH (white, RAL9016)

1 Half-space, 2π (on-wall) loading.

2 Continuous Pink Noise rating is IEC spectrum with 6 dB crest factor. Continuous program power is defined as 3 dB above Continuous Pink Noise Rating. In 8 ohm mode.

3 Half-space, 2π (on-wall) loading, average 80Hz – 20 kHz.

4 Calculated based on 2 hr power rating and measured sensitivity, exclusive of power compression.

JBL continually engages in research related to product improvement. Some materials, production methods, and design refinements are introduced into existing products without notice as a routine expression of that philosophy. For this reason, any current JBL product may differ in some respect from its published description, but will always equal or exceed the original design specifications unless otherwise stated. JBL continually engages in research related to product improvement. Changes introduced into existing products without notice are an expression of that philosophy.

Frequency Response & Impedance:

In half-space (2- π , on-wall, solid line) and full-space (4- π , dotted line)

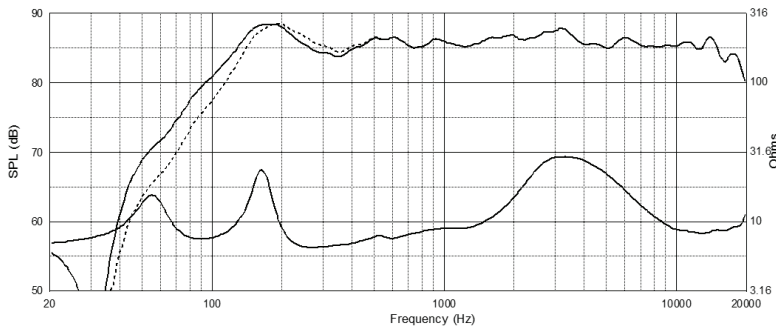

Beamwidth:

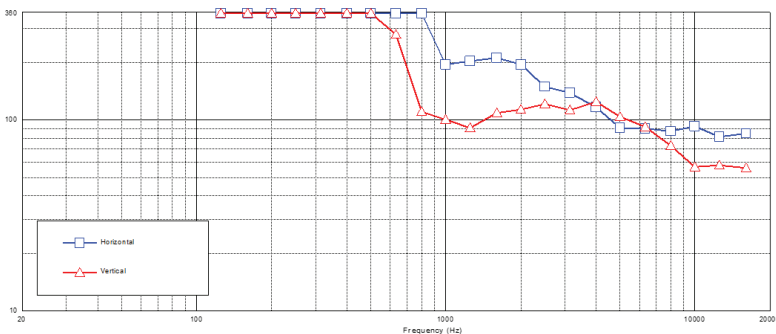

COL600

24-Inch (600 mm) Slim Column Loudspeaker



Directivity:

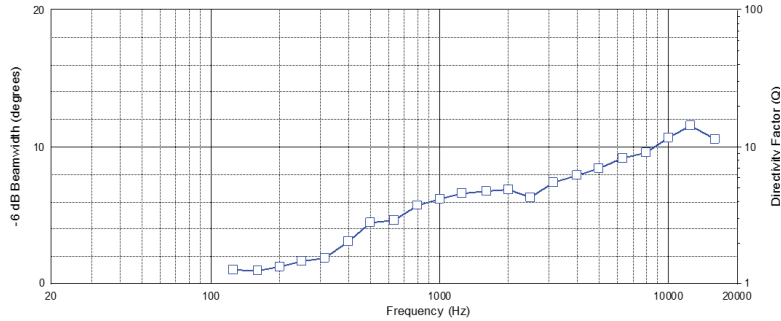

Horizontal Off-Axis Frequency Response:

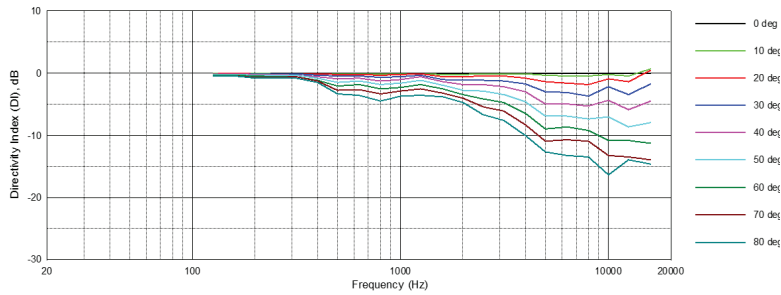

Vertical Off-Axis Frequency Response (Up):

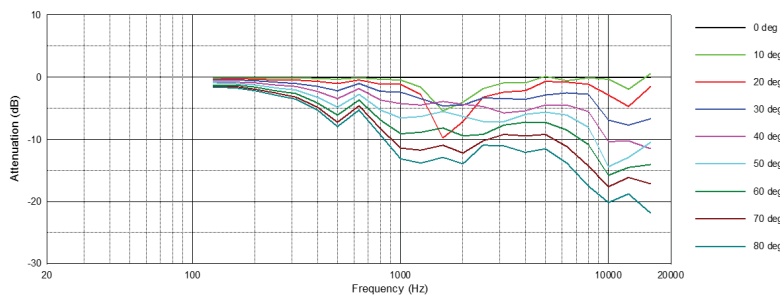

Vertical Off-Axis Frequency Response (Down):

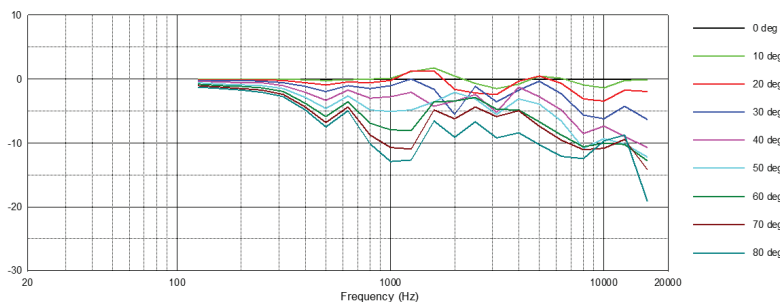

COL600

24-Inch (600 mm) Slim Column Loudspeaker



Dimensional Drawing:

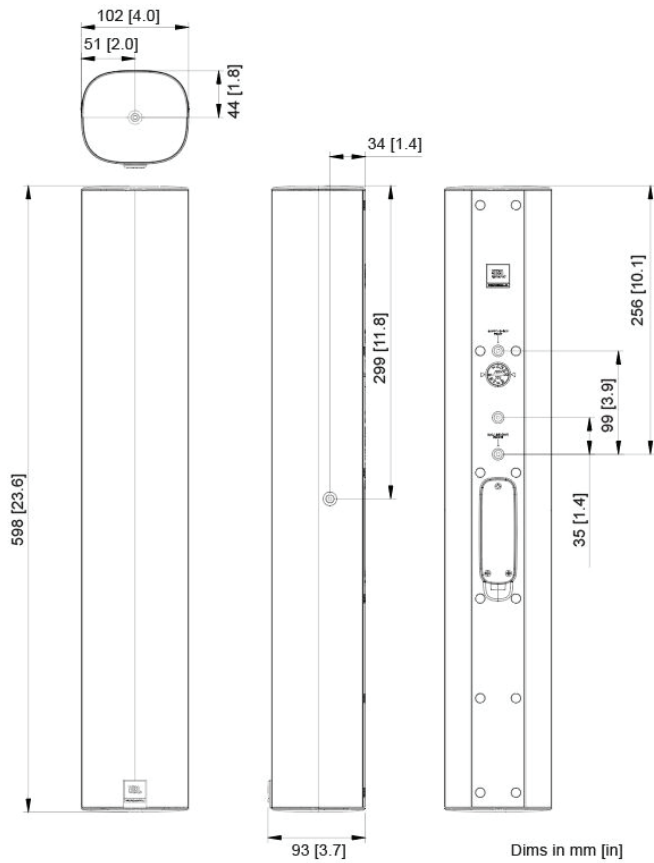

Wall Bracket:

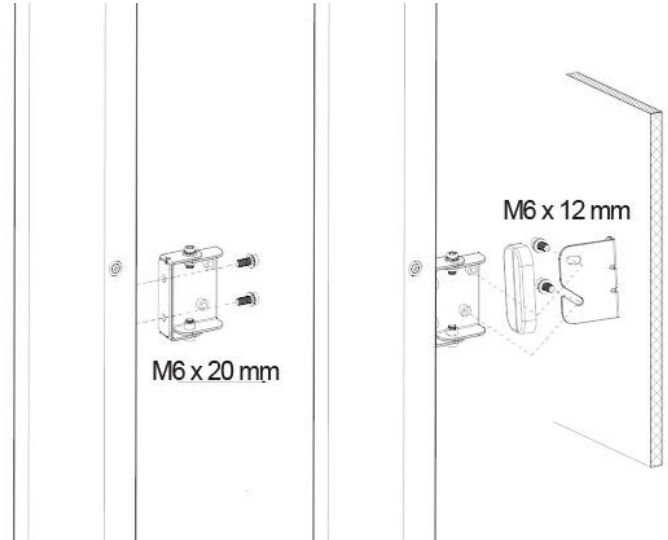

See COL Column Speaker Installation Guide for further information and details about installing this loudspeaker.



HARMAN Professional 8500 Balboa Blvd. Northridge, CA 91329 USA

© 2023 HARMAN International Industries, Incorporated. All rights reserved.
Features, specifications and appearance are subject to change without notice.

www.jblpro.com

SS-COL600
Issued: 9/2023