

MKC80

2-Way Coaxial Loudspeaker

- ▶ High output, compact coaxial loudspeaker
- ▶ Patented CSA coaxial horn provides superior control, fidelity and output
- ▶ Integrated M10 mouting, handle and pole mount
- ▶ Weather protection and transformer options
- ▶ Companion UX4403 amplifiers

OVERVIEW

The MKC series represents a major evolution of coaxial loudspeakers. Available as standard in black or white, the MKC series offers a full-suite of driver sizes allowing the series to span a powerful index of installation applications and configurations. The enclosures can be deployed in either horizontal or vertical orientations through the use of an pan & tilt wall bracket or a U-Bracket. Other deployment options include a pole stand mount with two available tilt positions. Equipped with a CSA aperture, MKC80 takes single speaker pattern control to new levels. The technology delivers consistent tonality throughout the entire coverage, area even at high SPL levels.



TECHNOLOGIES



Beamwidth Matched Crossovers Introduced over a decade ago for our MK series loudspeakers, EAW Engineers use carefully-designed HF horns and crossovers to eliminate polar irregularities through the crossover point.



Focusing™ Use of advanced digital signal processing to perfect the impulse response of a loudspeaker in the time domain. Eliminating horn "honk" and splashiness, this makes the loudspeaker sound like a studio monitor instead of a "PA" speaker.



DynO™ Dynamic Optimization actively tracks input spectrum and power delivery, continually wicking maximizing output and fidelity at any drive level.



Symmetry of Sources™ Symmetrical arrangement of acoustic sources along a common axis for utmost consistency throughout the coverage pattern.



Concentric Summation Array (CSA)™ A method of seamlessly integrating MF and HF components within a single horn. With CSA, multiple subsystems sum coherently, without interruption to either HF or MF wavefronts.

TECHNICAL SPECIFICATIONS

2-WAY COAXIAL LOUDSPEAKER

PERFORMANCE	
Max SPL¹ (12 dB Crest Factor)	132dB
Max SPL¹ (6 dB Crest Factor)	126dB
Operating Range²	60Hz-20kHz
Nominal Beamwidth³	90 x 60 degrees, rotatable
Axial Sensitivity	93dB
Calculated Axial Output	120dB Average, 132dB Peak
Nominal Phase	±15° from ideal high-pass filter
Input Impedance	8 ohms nominal, 7.4 ohms @ 270Hz minimum
Recommended HPF	60Hz 12dB/oct
ACCELERATED LIFE TEST ⁴	
LF/HF	450W @ 8ohms
CONFIGURATION	
LF Transducer, Loading	1x8in cone, 2in VC, Vented
HF Transducer, Loading	1x1-in exit, 35mm voice coil compression driver, Concentric Summation Array (CSA) loaded
Operating Modes	LF/HF, DSP w/ EAW Focusing & DynO
PHYSICAL	
Physical Rigging	2x M10 Suspension points 4 x M6 threaded pattern for wall or ceiling mount bracket 2x pairs of M6 threaded points for pole mount adapter
Dimensions (HxWxD)	16.6 x 10.0 x 10.5in (422 x 255 x 267mm)
Net Weight	22 lbs. (10kg)
Shipping Weight	Approx. 26 lbs. (11.8kg)
Mounting Accessories	U-Bracket Ceiling mount bracket Metal wall mount Pan/Tilt bracket
Input Connector	2x Neutrik NL4, 2-pin barrier strip

1 Calculated peak SPL at 1m with stated crest factor pink noise. Specified as whole space (free field) for full range loudspeakers, half space for subwoofers.
 2 Operating Range: Range where the processed Frequency Response stays within -10 dB SPL of the power averaged SPL within this range; measured on the geometric axis. Narrow band dips are excepted.
 3 Nominal Beamwidth: Design angle for the -6 dB SPL points, referenced to 0 dB SPL as the highest level.
 4 Accelerated Life Test: Maximum test input voltage applied with an EIA-426B defined spectrum; measured with recommended signal processing and Recommended Protection Filter.

INPUT

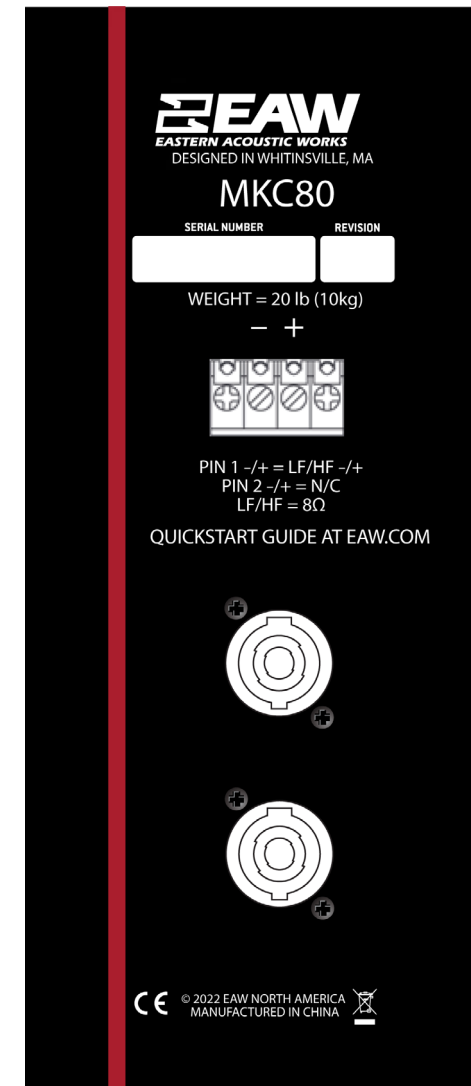

SIGNAL

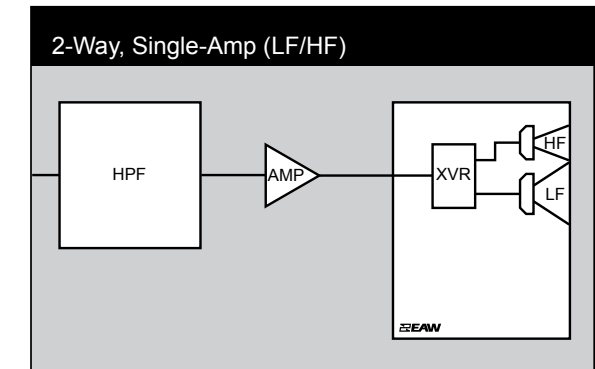

LEGEND

- LF/MF/HF:** Low Frequency / Mid Frequency / High Frequency.
- AMP:** User Supplied Power Amplifier –or– Integral Amplifier for NT products.
- XVR:** Passive LPFs, HPFs, and EQ integral to the loudspeaker.
- EAW Focusing:** Digital Signal Processor capable of implementing EAW Focusing.

RECOMMENDED AMPLIFIER CONFIGURATION

SINGLE-AMP



MODEL	PER CHANNEL	PER AMPLIFIER
UXA4403	2	8

EAW strongly recommends utilizing the processing setting to take full advantage of your speakers. Pair with EAW UXA Amps for the best performance of EAW Core Technologies

RIGGING CONFIGURATION



MOUNTING HARDWARE

EAW

DESCRIPTION	PART NUMBER
U-Bracket (BLK)	2071719-90
U-Bracket (WHT)	2071789-90
Pivoting Wall Mount Bracket (BLK)	2071833

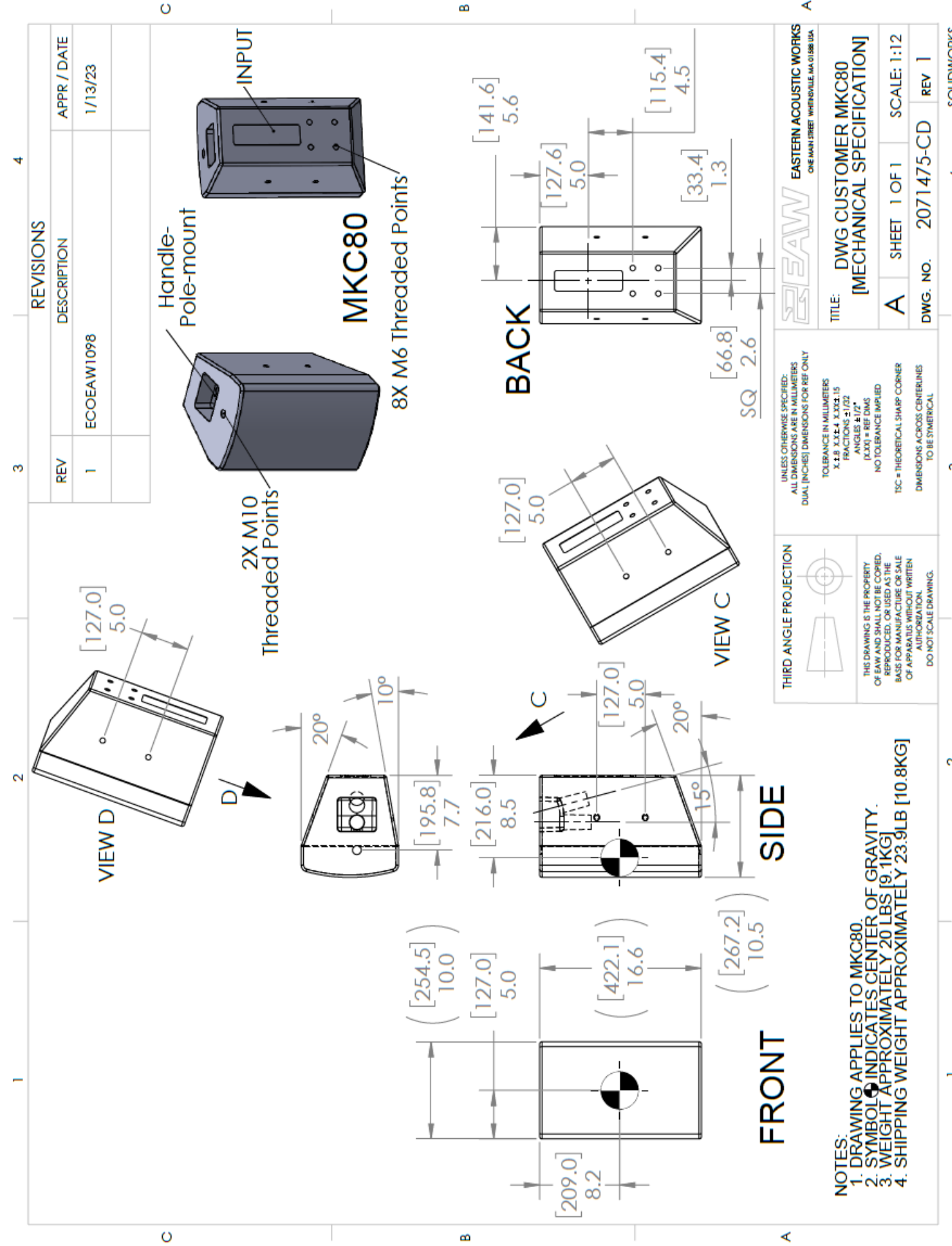

PERFORMANCE GRAPHS

FREQUENCY¹ ■=Overall Response Unprocessed

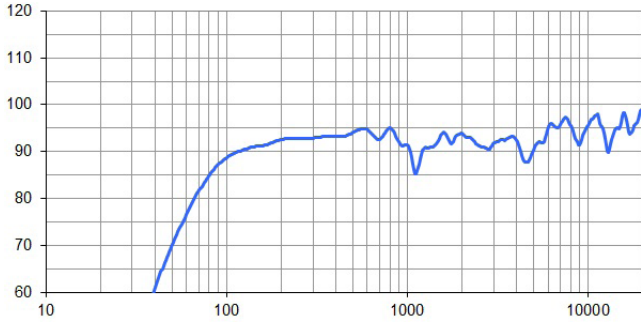

FREQUENCY¹ ■=Overall Response Processed

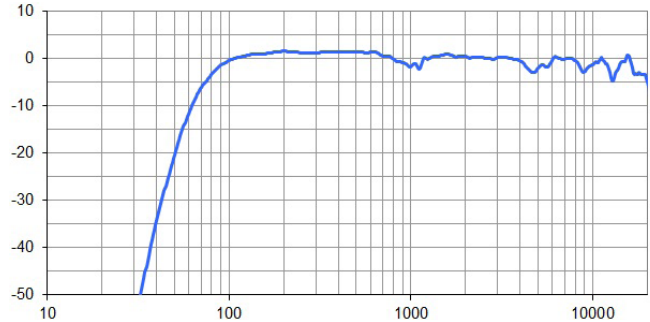

PHASE LINEARITY

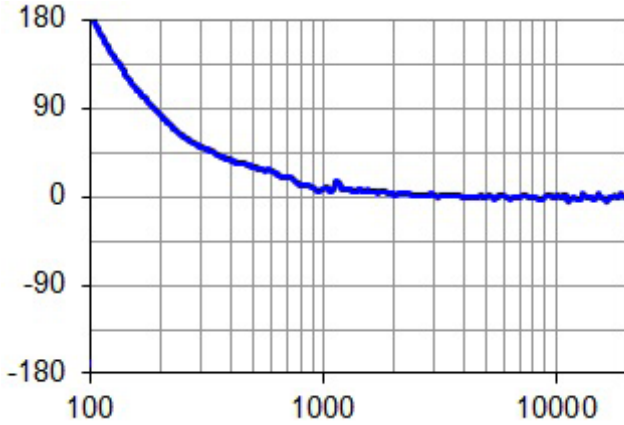

BEAMWIDTH² ■=Horizontal ■=Vertical

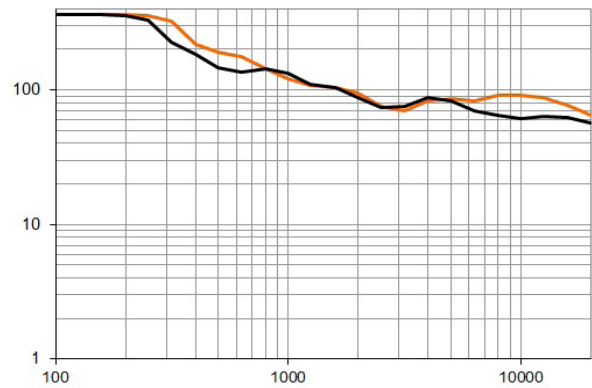

IMPEDANCE

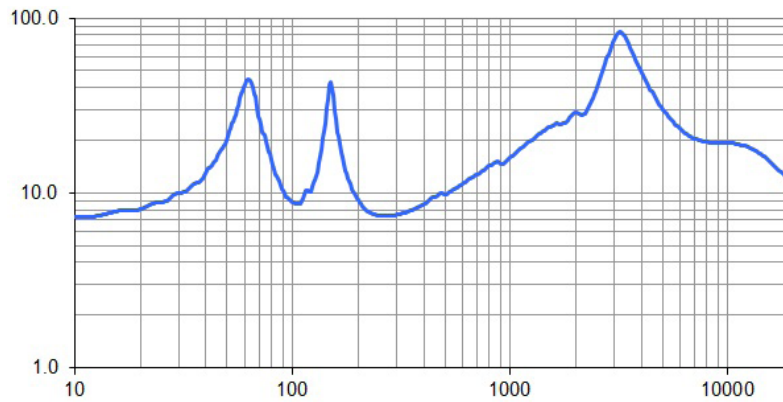

1 Variation in acoustic output level with frequency for a constant input signal. Processed: normalized to 0 dB SPL. Unprocessed inputs: 2 V (4 ohm nominal impedance), 2.83 V (8ohm nominal impedance), or 4 V (16 ohm nominal impedance) referenced to a distance of 1 m.

2 Average angle for each 1/3 octave frequency band where, starting from the rear of the loudspeaker, the output first reaches -6 dB SPL referenced to 0 dB SPL as the highest level. This method means the output may drop below -6 dB SPL within the beamwidth angle.