

Panasonic

BUSINESS

AW-UE150W [White Model]

AW-UE150K [Black Model]

4K Integrated Camera

AW-RP150GJ

Remote Camera Controller

Panasonic's 4K 60p/50p^{*1} 12G-SDI Supported PTZ Camera the Industry's First^{*2}

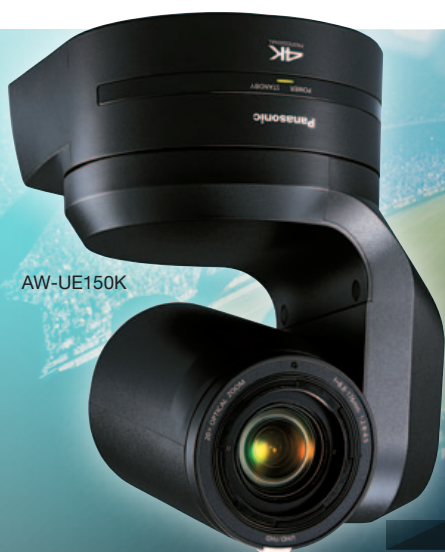

AW-UE150K



For indoor use

4K 60p/50p^{*1} output supported for superior image quality

75.1° field of view for wide-angle shooting

Optical 20x zoom



AW-UE150W



AW-RP150GJ

Large touch panel for easy usability

New joystick for flexible operability

*1: Actual output format is UHD (3840 x 2160) 59.94p/50p. *2: Internal investigation, Oct. 2018.

AW-UE150

4K 60p/50p*1 Output, High-Magnification Zoom and Wide-Angle Shooting for Flexible Video Production



AW-UE150W

4K Integrated Camera
[White Model]



AW-UE150K

4K Integrated Camera
[Black Model]



The next-generation PTZ camera supports high-quality video production in stadium, lecture halls, churches and other venues. Smooth and high-quality 4K 60p/50p*1, high-magnification zoom and a wide shooting angle expand the range of the PTZ camera's applications. The camera is equipped with a variety of interfaces and supports simultaneous 4K/HD operation which allows for versatility in current and future production systems.

* Power supply not included. An AC adaptor or PoE++ HUB is required.

► High-Quality 4K 60p/50p*1 Shooting

3840 x 2160 4K output and 59.94p/50p*1 shooting achieve extremely smooth video, even in live sports and other environments containing rapid movement.

■ Output format

4K	2160/59.94p, 2160/50p, 2160/29.97p*2, 2160/25p*2, 2160/24p*2, 2160/23.98p*2
HD	1080/59.94p, 1080/50p, 1080/29.97p*2, 1080/29.97PsF, 1080/25p*2, 1080/25PsF, 1080/23.98p*3, 1080/24p*2, 1080/23.98p*2, 1080/23.98PsF, 1080/59.94i, 1080/50i
	720/59.94p, 720/50p

► 1.0-type MOS Sensor Mounted

The large 1.0-type MOS sensor enables high sensitivity shooting with low noise. The sensor boasts a light-capturing area that is approximately four times larger than that of the 1/2.3-type sensor to guarantee a wide dynamic range.

► Optical 20x Zoom / Industry's First* 75.1° Horizontal Wide-Angle Shooting

Adding "i zoom" to our optical 20x zoom, maintains high resolution while enabling ultra-high resolution 32x zoom in HD mode and 24x zoom in 4K mode. This enables distant subjects to be captured clearly. Furthermore, 75.1° horizontal wide-angle shooting enables capture of the entire area, even when installation space is limited.

* Internal investigation, Nov. 2018.

■ Optical 20x Zoom Image Quality



* Images are simulated.

■ Horizontal 75.1° Shooting Range

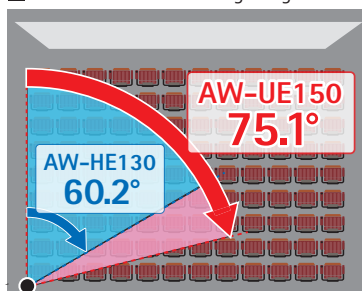

Camera Position



► HDR (HLG) Support*4

The camera supports HDR (High Dynamic Range) to prevent blown-out highlights and blocked-up shadows and enable picture quality close to that of the naked eye. Conforms to BT.2020.

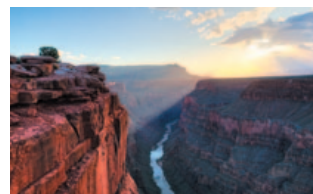

HDR Mode OFF

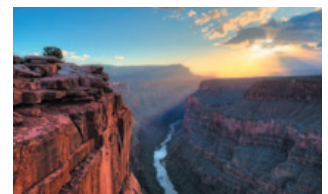

HDR Mode ON

* Images are simulated.

► Optical Image Stabilizer (OIS) Loaded

Vibrations of the mounted surface caused by doors opening and closing, audio systems and other installed equipment are automatically corrected to ensure stable shooting.

► Night Mode Support

Equipped with Night Mode for infrared shooting. The use of IR rays in low-light situations enables shooting in situations that would normally be difficult, such as when capturing wildlife (image output is black and white).



* Images are simulated.

► Incredible Pan and Tilt Performance

Pan and tilt operate from a minimum speed of 0.08°/s to a maximum of 180°/s in high-speed mode. This is approximately 3 times the speed of our current product*⁵ for rapid capture of the intended target. Furthermore, a low noise level of NC35 or less has been ensured when operating in normal mode, which is perfect for shooting in quiet environments*⁶.

■ Comparative Pan / Tilt Speeds

Our current product*⁵

Maximum speed of 60°/s

AW-UE150W/K

Maximum speed of 180°/s (in high-speed operation mode)

Approx.
3 times
the conventional
speed

► Cropping Function

Images shot in 4K can be output in their entirety while simultaneously cropping parts of those images. The cropping position can be specified from a maximum of 3 locations to enable simple operation from the Remote Camera Controller AW-RP150GJ, a web browser or other operations screen.



* Images are simulated.



Equipped with a large Tally Lamp that is easy to see from a distance

► Multiple Interfaces Supported

A wide range of outputs are supported: 12G-SDI, 3G-SDI, HDMI, IP and even Optical Fiber output. The addition of 4K/HD simultaneous output guarantees the right output for the operation at hand. 4K video can be down converted to HD directly within the camera.

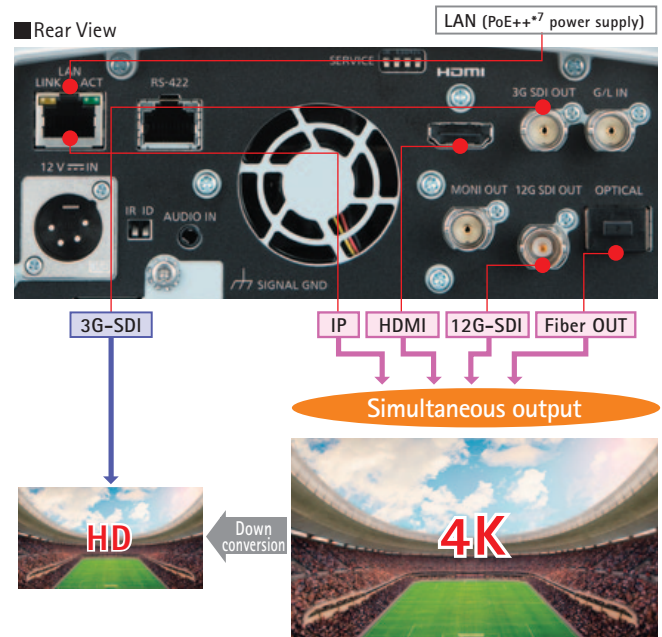

* Images are simulated.

*1: Actual output format is UHD (3840 x 2160) 59.94p/50p.

*2: Native output.

*3: It denotes "1080/23.98p over 59.94".

*4: The display color space does not completely comply with BT.2020. The color balance is shifted to display according to the BT.2020 color gamut.

*5: Comparison with our current product, AW-HE130W/K.

*6: Quietness, stationary accuracy, etc., in high-speed mode may vary from normal mode.

*7: Abbreviation of Power over Ethernet Plus Plus. Conforms to IEEE802.3bt.

▶ Adaptive Matrix prevents color overloaded from blue LEDs*

Equipped with an Adaptive Matrix function that automatically controls matrix calculation coefficients. This enables shooting while preventing color overloaded, even during live events and on stages with strong blue LED lights.

*Use may require a software version update.

▶ WEB UI Improved

Camera IP image output, settings and control can be performed using a web browser on a computer connected via an IP network. In addition to PCs and Macs, iPads, iPhones*, Androids and other mobile devices can be used for operation, and this pursuit of easy-to-use interfaces has enabled smooth camera control from remote locations.

*Use may require a software version update.

Camera control screen (Windows operation depicted.)



*For supported browsers, see specifications on page 10.

▶ AW-RP150GJ Connection for Large-Scale Production Systems

IP connection from the Remote Camera Controller AW-RP150GJ through a HUB (switching hub) enables control of up to 200 AW-UE150W/K units. Furthermore, a single AW-UE150W/K unit can be controlled from up to 5 AW-RP150GJ units.

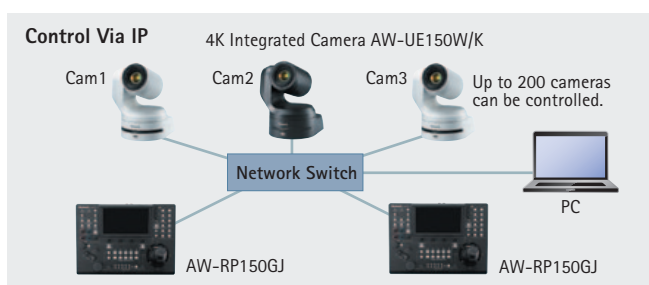

▶ Direct Broadcast via RTMP (Real-Time Messaging Protocol)

RTMP (Real-Time Messaging Protocol) is supported to enable direct upload of video to live-streaming services such as YouTube Live and Facebook Live. This means a live stream can be broadcast directly from the camera.

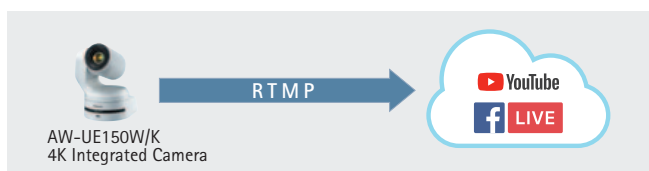

▶ NDI | HX Compatibility for Excellent Video Streaming Quality

The AW-UE150W/K can be upgraded to an NDI | HX compatible model if purchasing a license. Highly efficient NDI | HX compatibility enables high-quality video to be encoded and transmitted in real-time and input signals to be directly sent to a switcher (AV-HLC100) without the need for an IP decoder.

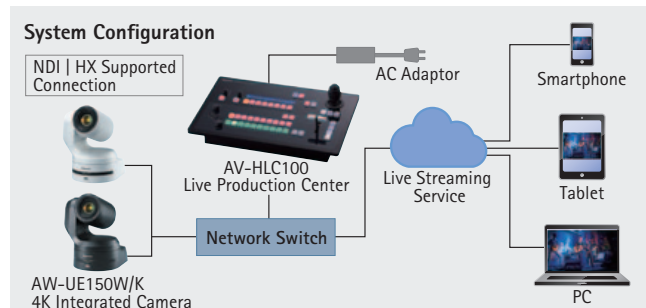

*4K image output not supported in NDI|HX mode.

*Contact your local Panasonic reseller for further information.

• NDI|HX, a technology of NewTek, Inc.

▶ JPEG Image Saving Function Equipped*

Up to 100 still images can be captured and saved as JPEG files to the built-in camera memory.

*Use may require a software version update.

▶ FreeD Support for Construction of AR/VR Systems*

Connection with AR/VR systems has been enabled via FreeD-compliant command output. Camera tracking information (pan/tilt/zoom/focus/iris) is output according to a synchronizing signal to facilitate construction of virtual systems without an encoder.

AR: Augmented Reality

VR: Virtual Reality

*Use may require a software version update.

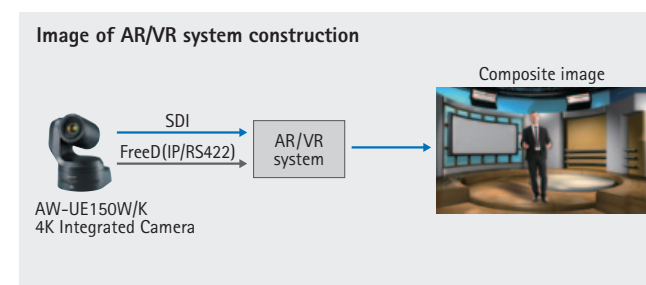

* Images are simulated.

► Optional Products

■ PC Software for Remote Camera Support

Supporting Lecture Capture with Auto Tracking function

Auto Tracking Software Key

Stand-Alone and Web App Versions

AW-SF100*1

Server Version

AW-SF200*1

2 Additional Licenses (for AW-SF200)

AW-SF202*1

3 Additional Licenses (for AW-SF200)

AW-SF203*1

A 30-day Free Trial is Available

- Motion detection and face detection technologies using video streaming from camera achieve smooth auto tracking regardless of where the person is facing. Installation of sensors and other devices are not necessary.
- GUI designed for intuitive operation.
- Operation with IP connection enables installation/control of cameras in remote classroom.
- AW-SF100 allows a single PTZ camera to be controlled on either a stand-alone or web application version. AW-SF200 operates on a server.
- The stand-alone version is easy to set up by installing software on a PC*2 and connecting PTZ cameras.
- The web application version enables camera control from a tablet, smartphone, desktop PC, etc.
- AW-SF200 enables simultaneous auto tracking and centralized control of multiple cameras.*3



AW-SF200 Main View

*1: Use may require a software version update.

*2: When the web application version is used, Auto Tracking Software needs to be installed on an HTTP server.

*3: Up to four cameras per server can be controlled simultaneously.

* Depending on the shooting environment, the system may not be able to detect or track the target correctly. Please use this software in an environment where the adjustment work can be performed by the operator to deal with errors in detection and auto tracking. * There is a 30-day free trial available for the Auto Tracking Software. Please read carefully the precautions for this software and check if it works correctly in your operating environment before you purchase "Auto Tracking Software Activation Key". For further information, please see "Download / Software Download" on the Panasonic website <<https://pro-av.panasonic.net/>>.

• The face recognition function is based upon the face recognition software developed by PUX Corporation.

Control multiple PTZ Cameras from PC

PTZ Control Center Free software

- Video can be checked during centralized management of multiple cameras.
- Camera control enabled via GUI for image quality adjustment, pan, tilt, zoom, etc. Touch panel operations are supported.
- Clicking the preset button attached to thumbnails enables simple recall of presets.
- Pan, tilt, zoom and other operations can also be controlled using game controllers made by other companies.



Main screen

Software that converts PTZ camera on your network into Super Web cam

PTZ Virtual USB Driver Free software

- Remote cameras on the network can be used as USB cameras for simple execution of web meetings with high image quality.
- Camera control enabled via GUI for image quality adjustment, pan, tilt, zoom, etc. Touch panel operations are supported.
- Up to 5 cameras can be registered.
- Automatic detection of connected cameras and network settings enabled.

* For further information on the optional software, please see "Download / Software Download" on the Panasonic website <<https://pro-av.panasonic.net/>>.

■ Optional Products

As of March, 2019

Remote Camera Controller AW-RP150GJ



Remote Camera Controller AW-RP50*4*5



Live Production Center AV-HLC100*4



Remote Operation Panel (ROP) AK-HRP1000GJ*4 AK-HRP1005GJ*4



Control Assist Camera AW-HEA10W/K*4



Wireless remote control AW-RM50G

(*AA*, *R6* or *LR6* battery x2 are not included.)



*4: Use may require a software version update.

*5: Some operation functions are restricted during connection with the AW-UE150W/K.

<About power supply>

An AC adapter is not included with the AW-UE150W/K. An XLR4 pin 12 V capacity power supply is required to supply the rated power consumption (48 W) of this device.

Intuitive Camera Control for Ease of Use and One-Person Operation



A ZOOM/FOCUS rocker mounted on the joystick manages pan and tilt operations for zoom and focus control and intuitive single-handed operation. The built-in touch display allows for easy and quick operation of all essential camera functions.

AW-RP150GJ

Remote Camera Controller

• Power supply not included. An AC adaptor or PoE+ HUB is required.

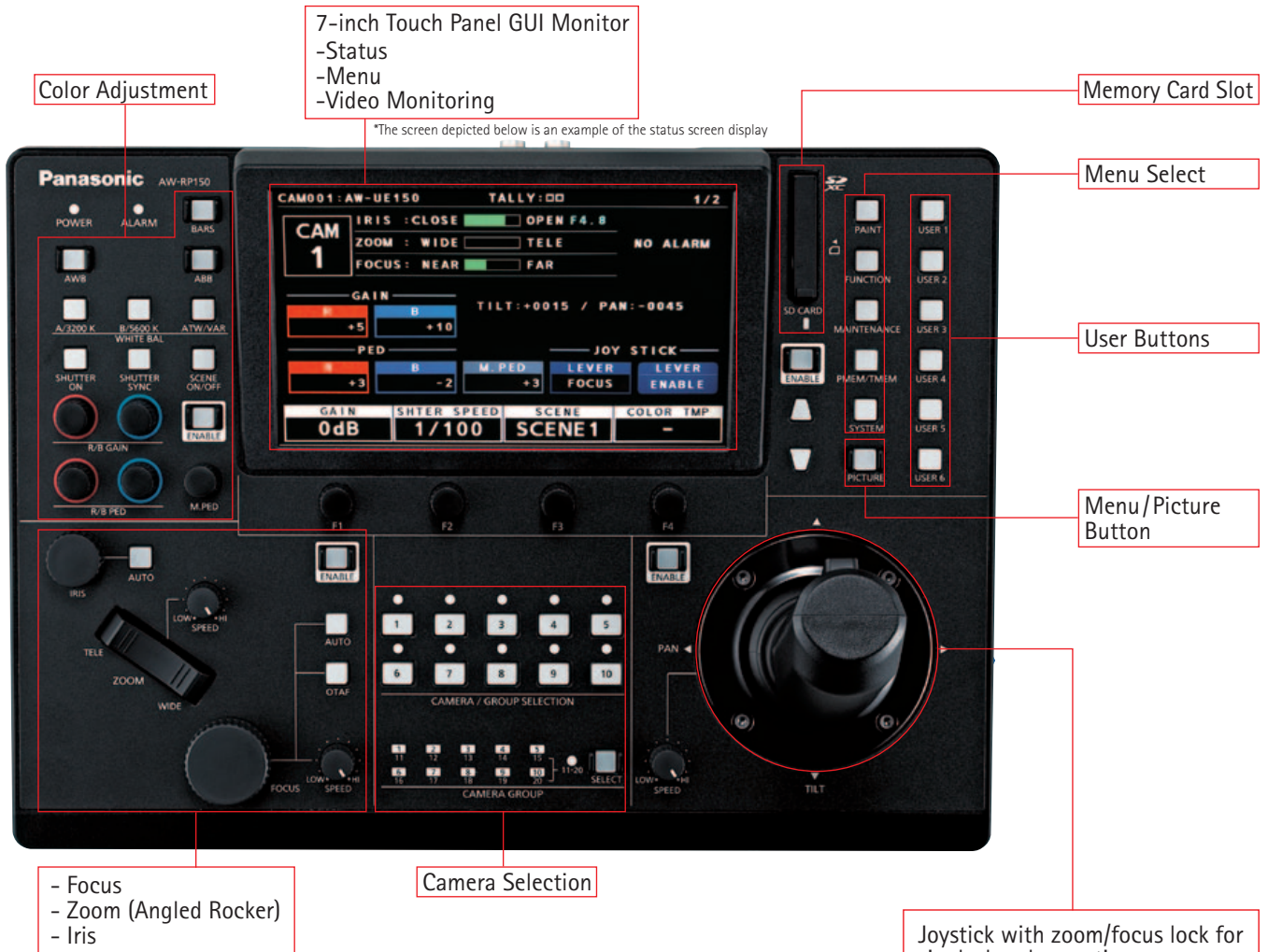

► Rear View

PoE+* support enables power supply via a LAN cable. Additionally, a dual system GPIO (general purpose input/output) terminal is equipped as standard.

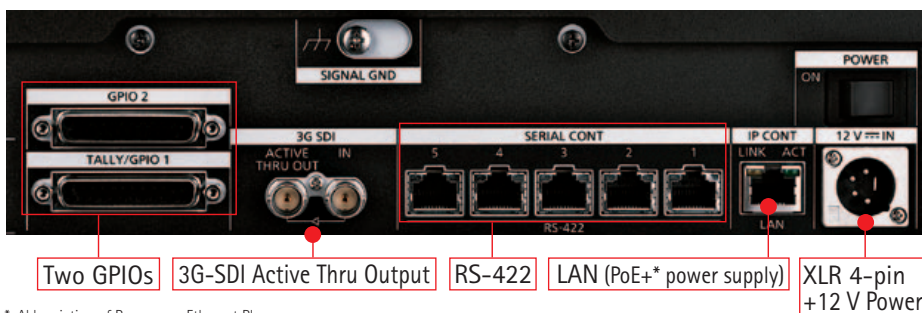

*: Abbreviation of Power over Ethernet Plus.



<About power supply>
An AC adaptor is not included with the AW-RP150GJ. An XLR4 pin 12 V capacity power supply is required to supply the rated power consumption (12 W) of this device.

▶ Touch Panel GUI for High-Quality Operability and Visibility

The touch panel GUI monitor supports camera image display during shooting as well as a variety of operations. The panel is equipped only with buttons that are frequently used, with menu and camera switching operations, indicators and other functions consolidated in the touch panel GUI.

■ Menu screen example

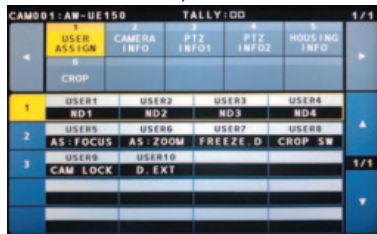

▶ Touch Focus Function Equipped

The focus is quickly aligned to the area touched by tapping the screen. In addition, the Focus in Red display assists with aligning focus by framing the part that is in-focus in red.

■ Focus assist (Focus in Red) screen example



▶ Camera Settings Copied to Multiple Cameras

Scene files, system settings files and other camera settings can be saved on the AW-RP150GJ SD card. These settings can then be copied to multiple cameras via the SD card. This massively reduces on-location setup time when shooting at events with large numbers of cameras.

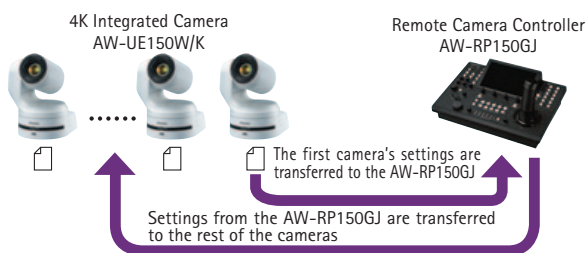

▶ Smooth Creation of Cropped Images

The cropping function loaded on the AW-UE150W/K can be controlled from the AW-RP150GJ. Images output from the AW-UE150W/K to the monitor can be cropped in three different locations displayed with colored frames (yellow/green/magenta), and fine-tuned with the joystick as you watch. Required images can be cropped precisely and simply.

■ Cropping screen example



*This screen is a monitor output image.

*The image is a composite.

▶ Preset Memory for Simple Camera Control

Registration of the camera angle and other remote camera settings allows them to be easily recalled from the touch panel GUI monitor. The movement speed for play back the preset memory can be set by the specified speed or time.

<Supported Presets>

- Pan and tilt position
- Zoom position
- Focus position
- Lens aperture (manual iris only)
- White balance settings
- Gain
- Crop position coordinates

▶ Tracing Memory for Memory and Recall of Camera Operations

The tracing memory function records a series of operation performed for the remote camera. Up to 5 minutes for 10 operations can be memorized for a single camera, and that trajectory can then be reproduced.

<Supported Presets>

- Pan and tilt position
- Zoom position
- Focus position
- Lens aperture (manual iris only)
- White balance settings
- Gain

▶ Multiple-Camera Connection Supported for Large-Scale Systems

IP connection via a switching hub can be used to control up to 200 remote cameras. Up to 5 remote cameras can be controlled in a serial connection.

■ Remote Camera Controller AW-RP150GJ-Compatible Panasonic Remote Cameras

As of March, 2019

<p>For indoor use </p> <p>4K 60p/50p*¹ output, 75.1° horizontal wide-angle output shooting</p> <p>4K Integrated Camera</p> <p>AW-UE150W/K</p> 	<p>For indoor use</p> <p>IP transfer output, 1/2.86-type 3MOS sensor-equipped</p> <p>HD Integrated Camera</p> <p>AW-HE130W/K*²</p> <p>NDI HX Compatible Premium HD Integrated Camera</p> <p>AW-HN130W/K*²</p> 	<p>For indoor use </p> <p>HDMI, USB and IP transfer for 4K image output</p> <p>4K Integrated Camera</p> <p>AW-UE70W/K*²</p> <p>NDI HX Compatible 4K Integrated Camera</p> <p>AW-UN70W/K*²</p> 
<p>For indoor use High portability and workability</p> <p>HD Integrated Camera</p> <p>AW-HE40SW/SK [SDI Model]*²</p> <p>AW-HE40HW/HK [HDMI Model]*²</p> <p>NDI HX Compatible HD Integrated Camera</p> <p>AW-HN40HW/HK*²</p> 	<p>For indoor use</p> <p>HD Integrated Camera</p> <p>AW-HE38HW/HK*²</p> <p>NDI HX Compatible Entry-level HD Integrated Camera</p> <p>AW-HN38HW/HK*²</p> 	<p>For outdoor use</p> <p>High sensitivity, S/N ratio and resolution with IP65 waterproofing and dustproofing</p> <p>Full-HD Outdoor Integrated Camera</p> <p>AW-HR140*²</p> 

*1: Actual output format is UHD (3840 x 2160) 59.94p/50p.

*2: Use may require a software version update.

Application Examples

Application 01: 4K Studio

Studio shooting of smooth, high-quality 4K 60p/50p*1 images

The AW-UE150W/K is capable of 4K 60p/50p*1 output for high-quality remote shooting in studio operations where high image quality is required. A large tally lamp has been equipped to make on-air cameras easily identifiable, even from far away.

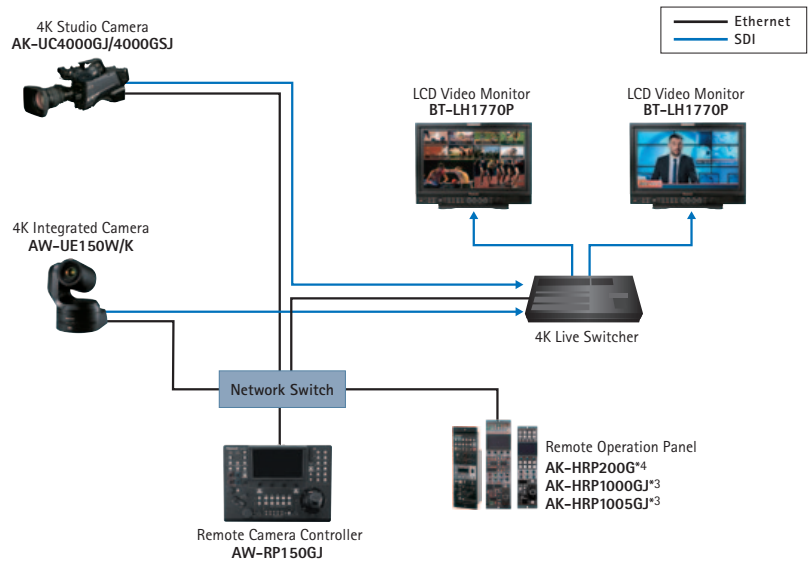

Application 02: Live Streaming

RTMP and NDI|HX support*2 enable streaming workflow to be optimized to the situation

Video being shot from a single camera can be uploaded directly from the AW-UE150W/K to a live-streaming service via RTMP. For multi-camera setups, use NDI|HX*2 to connect to the Live Production Center AV-HLC100*3. Multiple AW-UE150W/K units can be controlled from the AV-HLC100*3 for smooth live streaming.

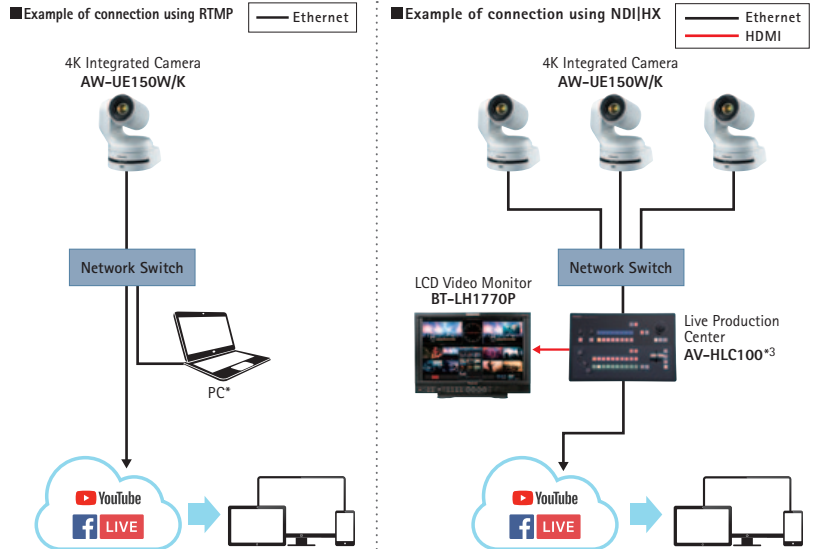

*A computer is required for server connection settings.

Application 03: Halls

High-magnification zoom and wide-angle shooting ensure targets are captured clearly in large venues

The large 1.0-type MOS sensor enables high-sensitivity shooting with little noise in halls and other dark locations. The optical 20x zoom further ensures that even far-away targets shot in large venues are captured clearly. 75.1° horizontal wide-angle shooting allows incredible flexibility in shooting location while still being able to capture the entire shot.

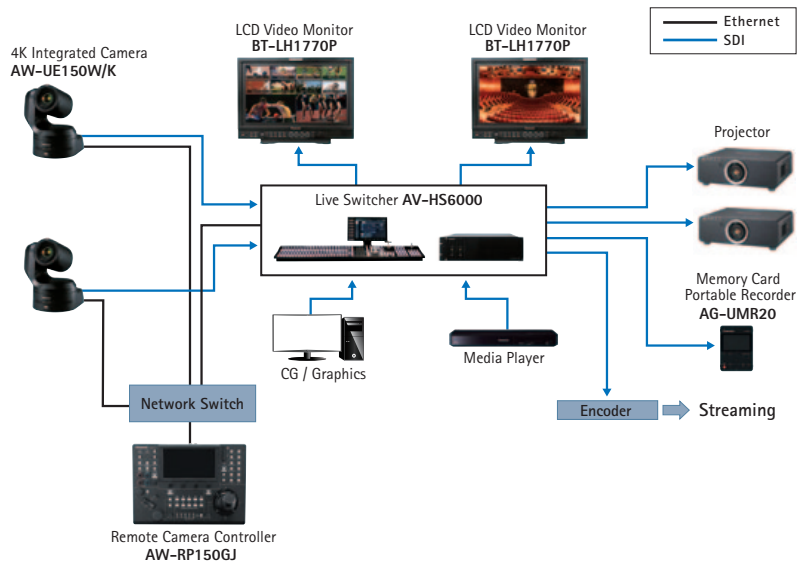

*1: Actual output format is UHD (3840 x 2160) 59.94p/50p.

*2: Contact your Panasonic sales representative for further details.

*3: Use may require a software version update.

*4: AW-UE150W/K not supported.

AW-UE150W/K Dimensions

Unit: mm (inches)

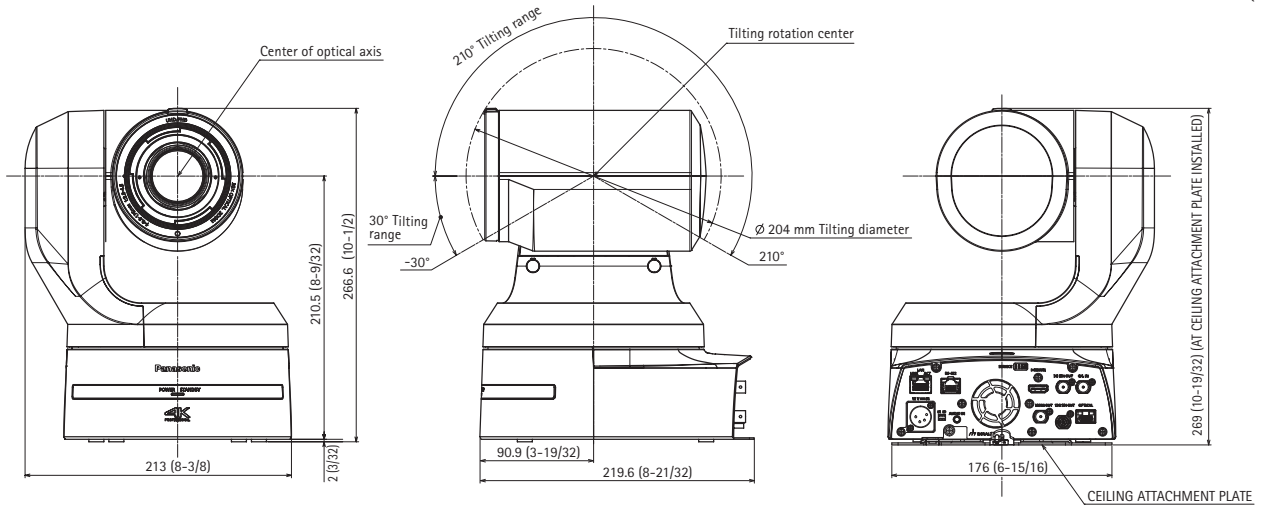

AW-UE150W/K Bottom View

Unit: mm (inches)

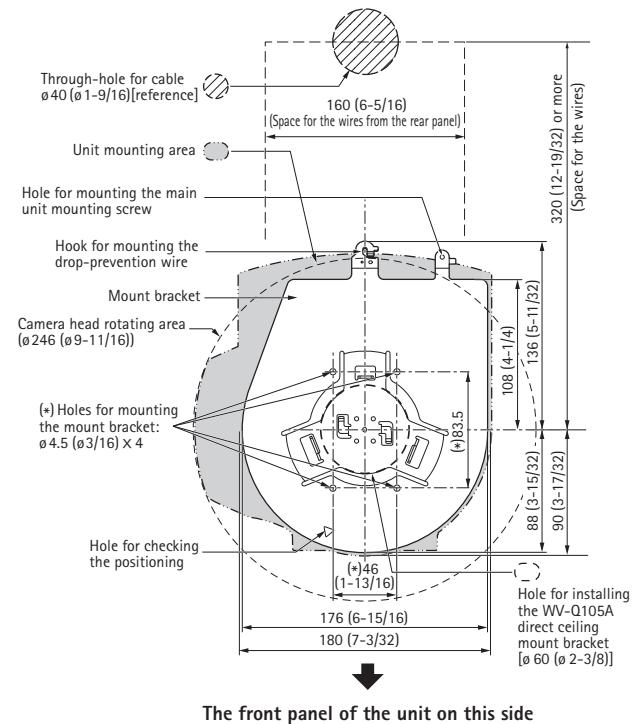

AW-RP150GJ Dimensions

Unit: mm (inches)

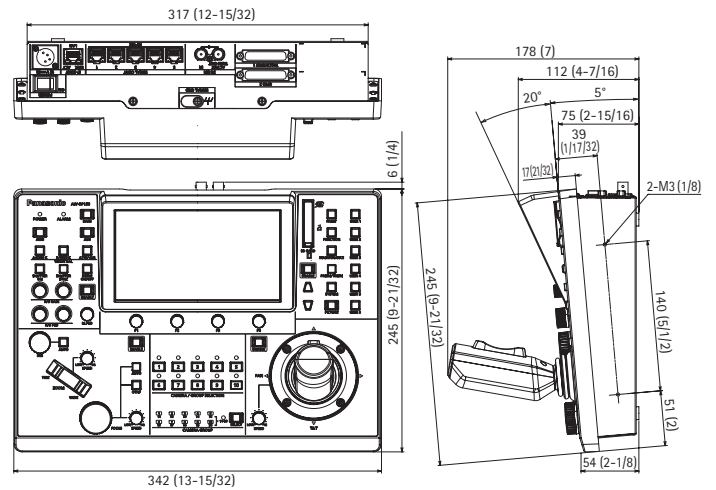

Specifications

AW-UE150W/K

<GENERAL>

Power Requirements:	12 V DC (10.8 V to 13.2 V)
PoE++:	IEEE802.3bt standard: DC 42 V to 57 V (Camera Input)
Current Consumption:	4.0 A (XLR IN connector), 1.2 A (PoE++ power supply)
Ambient Operating Temperature:	0 °C to 40 °C (32 °F to 104 °F)
Ambient Operating Humidity:	20 % to 90 % (no condensation)
Storage Temperature:	-20 °C to 50 °C (-4 °F to 122 °F)
Mass:	Approx. 4.2 kg (9.24 lb) (excluding mount bracket)
Dimensions (W x H x D):	213 mm x 267 mm x 219 mm (8-3/8 inches x 10-1/2 inches x 8-5/8 inches) (excluding protrusions, direct ceiling mount bracket)
Finish:	AW-UE150WP/AW-UE150WE: Pearl white AW-UE150KP/AW-UE150KE: Black
Controller Supported:	AW-RP150GJ, AW-RP50 [†] , AK-HRP1000GJ [†] , AK-HRP1005GJ [†]

<Camera Unit>

Imaging Sensors:	1-type 4K MOSx1										
Lens:	Motorized Optical 20x zoom, F2.8 to F4.5 [f=8.8 mm (11/32 inches) to 176.0 mm (6-15/16 inches); 35 mm (1-3/8 inches) equivalent: 24.5 mm (31/32 inches) to 490.0 mm (19-9/32 inches)]										
Zoom:	<ul style="list-style-type: none"> Optical zoom: 20x i.Zoom: UHD 24x, FHD 32x Digital zoom: 10x 										
Conversion Lens:	Not supported										
Angle of View Range:	Horizontal angle of view: 75.1° (wide) to 4.0° (tele) Vertical angle of view: 46.7° (wide) to 2.3° (tele) Diagonal angle of view: 82.8° (wide) to 4.6° (tele)										
Optical Filter:	Through, 1/4, 1/16, 1/64, IR through (IR through is used as "Night mode")										
Focus:	Switching between auto and manual										
Focus Distance:	Entire zooming range: 1000 mm (3.3 ft) Wide end: 100 mm (0.33 ft)										
Color Separation Optical System:	1MOS										
Standard Sensitivity:	F9, 2000 lx (When normal mode is selected)										
Minimum Illumination:	2 lx (F2.8, 59.94p, 50IRE, 42 dB, without accumulation)										
S/N:	60 dB or more										
Horizontal Resolution:	1600 TV lines Typ (Center area)										
Gain Selection:	Auto, 0 dB to 36 dB ² Super Gain function equipped : 37 dB to 42 dB										
Frame Mix ³ :	0 dB, 6 dB, 12 dB, 18 dB, 24 dB										
Electronic Shutter Speed:	<table border="1"> <tr> <td>59.94p/59.94i</td> <td>1/60, 1/100, 1/120, 1/250, 1/500, 1/1000, 1/2000, 1/4000, 1/8000, 1/10000</td> </tr> <tr> <td>29.97p</td> <td>1/30, 1/60, 1/100, 1/120, 1/250, 1/500, 1/1000, 1/2000, 1/4000, 1/8000, 1/10000</td> </tr> <tr> <td>23.98p/24p</td> <td>1/24, 1/48, 1/60, 1/100, 1/120, 1/250, 1/500, 1/1000, 1/2000, 1/4000, 1/8000, 1/10000</td> </tr> <tr> <td>50p/50i</td> <td>1/60, 1/100, 1/120, 1/250, 1/500, 1/1000, 1/2000, 1/4000, 1/8000, 1/10000</td> </tr> <tr> <td>25p</td> <td>1/25, 1/50, 1/60, 1/100, 1/120, 1/250, 1/500, 1/1000, 1/2000, 1/4000, 1/8000, 1/10000</td> </tr> </table>	59.94p/59.94i	1/60, 1/100, 1/120, 1/250, 1/500, 1/1000, 1/2000, 1/4000, 1/8000, 1/10000	29.97p	1/30, 1/60, 1/100, 1/120, 1/250, 1/500, 1/1000, 1/2000, 1/4000, 1/8000, 1/10000	23.98p/24p	1/24, 1/48, 1/60, 1/100, 1/120, 1/250, 1/500, 1/1000, 1/2000, 1/4000, 1/8000, 1/10000	50p/50i	1/60, 1/100, 1/120, 1/250, 1/500, 1/1000, 1/2000, 1/4000, 1/8000, 1/10000	25p	1/25, 1/50, 1/60, 1/100, 1/120, 1/250, 1/500, 1/1000, 1/2000, 1/4000, 1/8000, 1/10000
59.94p/59.94i	1/60, 1/100, 1/120, 1/250, 1/500, 1/1000, 1/2000, 1/4000, 1/8000, 1/10000										
29.97p	1/30, 1/60, 1/100, 1/120, 1/250, 1/500, 1/1000, 1/2000, 1/4000, 1/8000, 1/10000										
23.98p/24p	1/24, 1/48, 1/60, 1/100, 1/120, 1/250, 1/500, 1/1000, 1/2000, 1/4000, 1/8000, 1/10000										
50p/50i	1/60, 1/100, 1/120, 1/250, 1/500, 1/1000, 1/2000, 1/4000, 1/8000, 1/10000										
25p	1/25, 1/50, 1/60, 1/100, 1/120, 1/250, 1/500, 1/1000, 1/2000, 1/4000, 1/8000, 1/10000										
Synchro Scan:	<table border="1"> <tr> <td>59.94p/59.94i</td> <td>60.00 Hz to 7200 Hz</td> </tr> <tr> <td>29.97p</td> <td>30.00 Hz to 7200 Hz</td> </tr> <tr> <td>23.98p/24p</td> <td>24.00 Hz to 7200 Hz</td> </tr> <tr> <td>50p/50i</td> <td>50.00 Hz to 7200 Hz</td> </tr> <tr> <td>25p</td> <td>25.00 Hz to 7200 Hz</td> </tr> </table>	59.94p/59.94i	60.00 Hz to 7200 Hz	29.97p	30.00 Hz to 7200 Hz	23.98p/24p	24.00 Hz to 7200 Hz	50p/50i	50.00 Hz to 7200 Hz	25p	25.00 Hz to 7200 Hz
59.94p/59.94i	60.00 Hz to 7200 Hz										
29.97p	30.00 Hz to 7200 Hz										
23.98p/24p	24.00 Hz to 7200 Hz										
50p/50i	50.00 Hz to 7200 Hz										
25p	25.00 Hz to 7200 Hz										
Gamma:	HD / FILMLIKE1 / FILMLIKE2 / FILMLIKE3 / FILM REC / VIDEO REC / HLG										
White Balance:	ATW : 3200K, 5600K ATW Speed : Normal / Slow / Fast AWB : AWB-A / AWB-B VAR (selectable between 2000K and 15000K by designating a value)										
Chroma Amount Variability:	OFF, -99 % to 99 %										
Scene File:	Scene1, Scene2, Scene3, Scene4										
Output Format:	<table border="1"> <tr> <td>4K</td> <td>2160/59.94p, 2160/50p, 2160/29.97p*, 2160/25p*, 2160/24p*, 2160/23.98p*</td> </tr> <tr> <td>HD</td> <td>1080/59.94p, 1080/50p, 1080/29.97p*, 1080/29.97PsF, 1080/25p*, 1080/25PsF, 1080/23.98p*, 1080/24p*, 1080/23.98p*, 1080/23.98PsF, 1080/59.94i, 1080/50i, 720/59.94p, 720/50p</td> </tr> </table>	4K	2160/59.94p, 2160/50p, 2160/29.97p*, 2160/25p*, 2160/24p*, 2160/23.98p*	HD	1080/59.94p, 1080/50p, 1080/29.97p*, 1080/29.97PsF, 1080/25p*, 1080/25PsF, 1080/23.98p*, 1080/24p*, 1080/23.98p*, 1080/23.98PsF, 1080/59.94i, 1080/50i, 720/59.94p, 720/50p						
4K	2160/59.94p, 2160/50p, 2160/29.97p*, 2160/25p*, 2160/24p*, 2160/23.98p*										
HD	1080/59.94p, 1080/50p, 1080/29.97p*, 1080/29.97PsF, 1080/25p*, 1080/25PsF, 1080/23.98p*, 1080/24p*, 1080/23.98p*, 1080/23.98PsF, 1080/59.94i, 1080/50i, 720/59.94p, 720/50p										

<Synchronization System>

Internal / External synchronization (BBS / Tri-level sync)

<INPUT>

Input Connector:	DC 12 V IN, G/L IN (BNC) • BBS (Black Burst Sync), tri-level sync supported
------------------	--

<OUTPUT>

Video Output:	HDMI	HDMI 2.0 standard 4:2:2/10bit • HDCP is not supported. • Viera Link is not supported.
	12G-SDI OUT	SMPTE 2082-1 standard / 75 Ω (BNC x 1)
	3G-SDI OUT	SMPTE292 / 75 Ω (BNC x 1) • Level-A/Level-B supported
	MONI OUT	SMPTE292 / 75 Ω (BNC x 1)
	Optical Fiber	SFP+ standard Single Fiber • The signal sent is the same as 12G-SDI OUT. • This unit does not support input by optical signals.

<INPUT/OUTPUT>

Input / Output Connector:	LAN	LAN connector for IP control (RJ-45)
	RS-422	CONTROL IN RS-422A (RJ-45)
	MIC/LINE input	<ul style="list-style-type: none"> ø 3.5 mm stereo mini jack Input impedance: High impedance • During MIC input Supported mic: Stereo mic (plug-in power, on/off switching via menu) Supply voltage: 2.5 V ± 0.5 V Mic input sensitivity: Approx. -40 dBV ± 3 dBV (0 dB=1 V/Pa, 1 kHz) • During LINE input Input level: Approx. -10 dBV ± 3 dBV

<Pan-tilt Head Unit>

Camera/Pan-tilt Head Control:	IP connecting cable • LAN cable ^{6,7} : (category 5e or above, straight cable / crossover cable) max. 100 m (328 ft)
	AW protocol connecting cable LAN cable ⁶ (category 5e or above, straight cable) max. 1000 m (3280 ft)
Installation Method:	Stand-alone (Desktop) or suspended (Hanging)*
Pan/tilt Operation Speed:	Minimum speed 0.08°/s Maximum speed 60°/s or higher* • Maximum speed is 180°/s in high-speed mode
Panning Range:	±175°
Tilting range:	-30° to 210°**10
Quietness:	NC35 or less

<Supported operating systems and web browsers*11>

Supported operating systems and web browsers:	Windows	Microsoft® Windows® 7, 10 Windows® Internet Explorer® 11 (64-bit/32-bit) Microsoft Edge Google Chrome
	Mac	Mac OS 10.13, Mac OS 10.12, Mac OS 10.11, Safari 11, Google Chrome
	iPhone / iPad	iOS 11.4.1 Google Chrome

<IP Streaming>

Image Streaming Mode:	JPEG (MJPEG), H.264, H.265
Image Resolution:	3840x2160, 1920x1080, 1280x720, 640x360, 320x180
Image Transmission setting (JPEG):	Frame Rate: Maximum 30 fps Image quality (Fine / Normal)
Image Transmission Setting (H.264):	<ul style="list-style-type: none"> ■ Image quality (Motion priority / Image quality priority) UHD 60 fps / 50 fps ■ Transmission Type: Unicast port (AUTO) Unicast port (MANUAL) Multicast port ■ Transmission Priority Constant bit rate Frame rate Best effort

Image Transmission Setting (H.264):	<ul style="list-style-type: none"> ■ Frame Rate [60Hz] 5fps/15fps/30fps/60fps (UHD: 30fps, 60fps) [50Hz] 5fps/12.5fps/25fps/50fps (UHD: 25fps, 50fps) ■ Max Bit Rate HD : 512kbps/768kbps/1024kbps/1536kbps/2048kbps/3072kbps/4096kbps/6144kbps/8192kbps/10240kbps/12288kbps/14336kbps/16384kbps/20480kbps/24576kbps/32768kbps/40960kbps/51200kbps/76800kbps UHD: 12800kbps/25600kbps/51700kbps/76800kbps
Image Transmission Setting (H.265):	<ul style="list-style-type: none"> ■ Image Transmission Type: Unicast port (AUTO) Unicast port (MANUAL) Multicast port ■ Frame Rate [60Hz] 30fps [50Hz] 25fps ■ Max Bit Rate 8192kbps/12800kbps/25600kbps/51200kbps/76800kbps

Audio Compression Type:	AAC-LC, 48 kHz / 16 bit / 2ch
Supported Protocol:	<ul style="list-style-type: none"> ■ IPv6 : TCP / IP, UDP / IP, HTTP, HTTPS, DNS, NTP, DHCPv6, RTP, MLD, ICMP, ARP, RTMP ■ IPv4 : TCP / IP, UDP / IP, HTTP, HTTPS, RTSP, RTP / RTCP, DHCP, DNS, DDNS, NTP, UPnP, IGMP, ICMP, ARP, RTMP

<Other Function>

NDI support*12: NDI | HX

Tally LED display color: red / green

*1: Use may require a software version update. *2: 1 dB step increments can be set. *3: This cannot be configured when the format is 2160/29.97p, 2160/23.98p, 2160/24p, 2160/25p, 1080/29.97p, 1080/23.98p(59.94i), 1080/29.97PsF, 1080/23.98PsF, 1080/25p, 1080/25PsF. *4: Native output. *5: It denotes "1080/23.98p over 59.94i". *6: Use of an STP (shielded twisted pair) cable is recommended. *7: Category 6 or more is used when sending 4K images. *8: To ensure safety, the unit must be secured using the mount bracket supplied. *9: Quietness, stationary accuracy, etc., in high-speed mode may vary from normal mode. *10: Depending on the pan or tilt position, the camera may be reflected in the image. *11: Supported OS indicated are for browsers current as of October 2018. See "Service and Support / PASS" on the Panasonic website (<https://pro-av.panasonic.net/en/>) for the latest information on browser support. *12: Contact your local Panasonic vendor for further information.

AW-RP150GJ**<GENERAL>**

Power Requirements:	12 V DC (10.8 V to 13.2 V)
PoE+:	IEEE802.3at standard: DC 42 V to 57 V (Camera Input)
Current Consumption:	1.0 A (Connector Input) 0.6 A (PoE+ power supply)
Ambient Operating Temperature:	0 °C to 40 °C (32 °F to 104 °F)
Allowable Humidity:	20% to 90% (no condensation)
Storage Temperature:	-20 °C to 50 °C (-4 °F to 122 °F)
Weight:	Approx. 3.2 kg (7.05 lb)
Dimensions (W x H x D):	342 mm x 178 mm x 245 mm (13-15/32 inches x 7 inches x 9-21/32 inches) (excluding protrusions)
Connection Supported Equipment:	IP/RS422 AW-UE150W/K, AW-HR140*, AW-HE130W/K*, AW-HN130W/K*, AW-UE70W/K*, AW-UN70W/K*, AW-HE40 Series*, AW-HN40HW/HK*, AW-HE38HW/HK*, AW-HN38HW/HK*

<Input/Output Connectors>

Input:	DC 12 V IN	XLR 4-pin
	3G-SDI IN	SMPTE292 / 75 Ω (BNC x 1) Supported formats: 1080/59.94p*, 1080/50p*, 1080/59.94i, 1080/50i, 1080/23.98p, 1080/25p, 1080/23.98PsF, 1080/25PsF
Output:	ACTIVE THRU OUT	SMPTE292 / 75 Ω (BNC x 1)
Input/Output:	IP CONT	100BASE-TX PoE+ input Connection cable: LAN cable, max. 100 m (328 ft) • When connecting the unit via a switching hub: Straight cable or a cross cable (category 5 cable), STP (Shielded Twisted Pair) cable recommended • When connecting the unit directly: Crossover cable (category 5 cable), STP (Shielded Twisted Pair) cable recommended
	SERIAL CONT (RJ-45):	RS-422 (control signals for remote cameras), TALLY OUT Connecting cable: Straight cable (category 5e or better shielded cable), max. 1000 m (3280 ft) TALLY OUT: Open collector output (negative logic) Maximum voltage resistance DC 24 V, Maximum current 50 mA

Input/Output:	TALLY/GPIO 1	D-sub 25-pin, female, inch thread TALLY IN : 10 inputs (for receiving photocoupler signals) GPI : 6 inputs (for receiving photocoupler signals) GPIO : 5 inputs (for receiving photocoupler signals) or 5 outputs (open collector outputs, negative logic) • Input/output switched with menu settings
	GPIO 2	D-sub 25-pin, female, inch thread GPI : 10 inputs (for receiving photocoupler signals) GPIO : 10 inputs (for receiving photocoupler signals) or 10 outputs (open collector outputs, negative logic) • Input/output switched with menu settings Reserve connectors: 2 connectors (For future expansion feature)
LCD Display:	7-inch Touch Panel GUI Monitor (WVGA (800x480))	
SD Memory Card Slot :	SDHC / SDXC Memory Card Slot x 1	

<Connection Specifications >

No. of Connectable Cameras:	200 (IP), 5 (RS422)
No. of Camera Selection Buttons:	10
No. of Camera Groups:	20 (10 units per 1 group)

<Memory>

Preset Memory:	No. of memory presets	100
Tracing Memory:	No. of cameras	Cam1 to Cam10
	Recording time, no. of memory settings	Maximum 5 min. total per camera, maximum of 10 settings per camera

<Other Functions>

No. of User Assignable Buttons: 6 + up to 10 on the LCD menu

Pan / Tilt Speed Adjustment: 7 levels

Tally LED Display Color: green / red

*1: Use may require a software version update.
*2: Level-A support only.

■ Compatible Third-Party Equipment

Finisar Corporation

8G Fibre Channel (8GFC)
10km SFP+ Optical Transceiver
FTLF1428P3BNV
Operation-verified in Oct. 2018



16G Fibre Channel (16GFC)
10km SFP+ Optical Transceiver
FTLF1429P3BNV
Operation-verified in Oct. 2018



AJA Video Systems

1-Channel Single-Mode LC Fiber to
12G-SDI Receiver
FiDO-R-12G
Operation-verified in Oct. 2018



Blackmagic Design

Teranex Mini Optical to HDMI 12G
Operation-verified in Oct. 2018



GeoVision Inc.

PoE Adapter
GV-PA901
Operation-verified in Feb. 2019



PoE++

PLANET Technology Corp.

Layer 3 8-Port 10/100/1000T 802.3bt
PoE + 2-Port 10/100/1000T + 2-Port
10G SFP+ Managed Switch
GS-5220-8UP2T2X
Operation-verified in Oct. 2018



PoE++

Third-Party
Inquiries

- <Finisar Corporation> <https://www.finisar.com/how-buy>
- <AJA Video Systems, Inc.> TEL: +1-530-274-2048 MAIL: Sales@aja.com <https://www.aja.com/where-to-buy>
- <Blackmagic Design> TEL: +61 3 9682 4770 <https://www.blackmagicdesign.com/company>
- <GeoVision Inc.> TEL: +886-2-8797-8376 MAIL: sales@geovision.com.tw
- <PLANET Technology Corp.> <https://www.planet.com.tw/en> MAIL: sales@planet.com.tw

* Microsoft®, Windows®, Windows® XP, Windows® 7, Windows® 8, Windows® 8.1, Windows® 10 and Internet Explorer® are either registered trademarks or trademarks of Microsoft Corporation in the United States and other countries.
* Apple, Mac, OS X, iPhone, iPod Touch, iPad, and Safari are registered trademarks of Apple Inc., in the United States and other countries.
* Android™ is a trademark of Google Inc.
* "YouTube" and the "YouTube logo" are registered trademarks of Google Inc.
* "Facebook" is a registered trademark of Facebook, Inc.

* Specifications are subject to change without notice.

Panasonic®

Panasonic Corporation
Connected Solutions Company

2-15 Matsuba-cho, Kadoma, Osaka 571-8503 Japan



For more information, please visit Panasonic web site
<https://pro-av.panasonic.net/en/qr/>



Factories of AVC Networks Company have received ISO14001:2004-the Environmental Management System certification. (Except for 3rd party's peripherals.)



Broadcast and
Professional
AV Website



Contact Information



Facebook



Mobile App